

POP[®]

Blind Riveting Systems

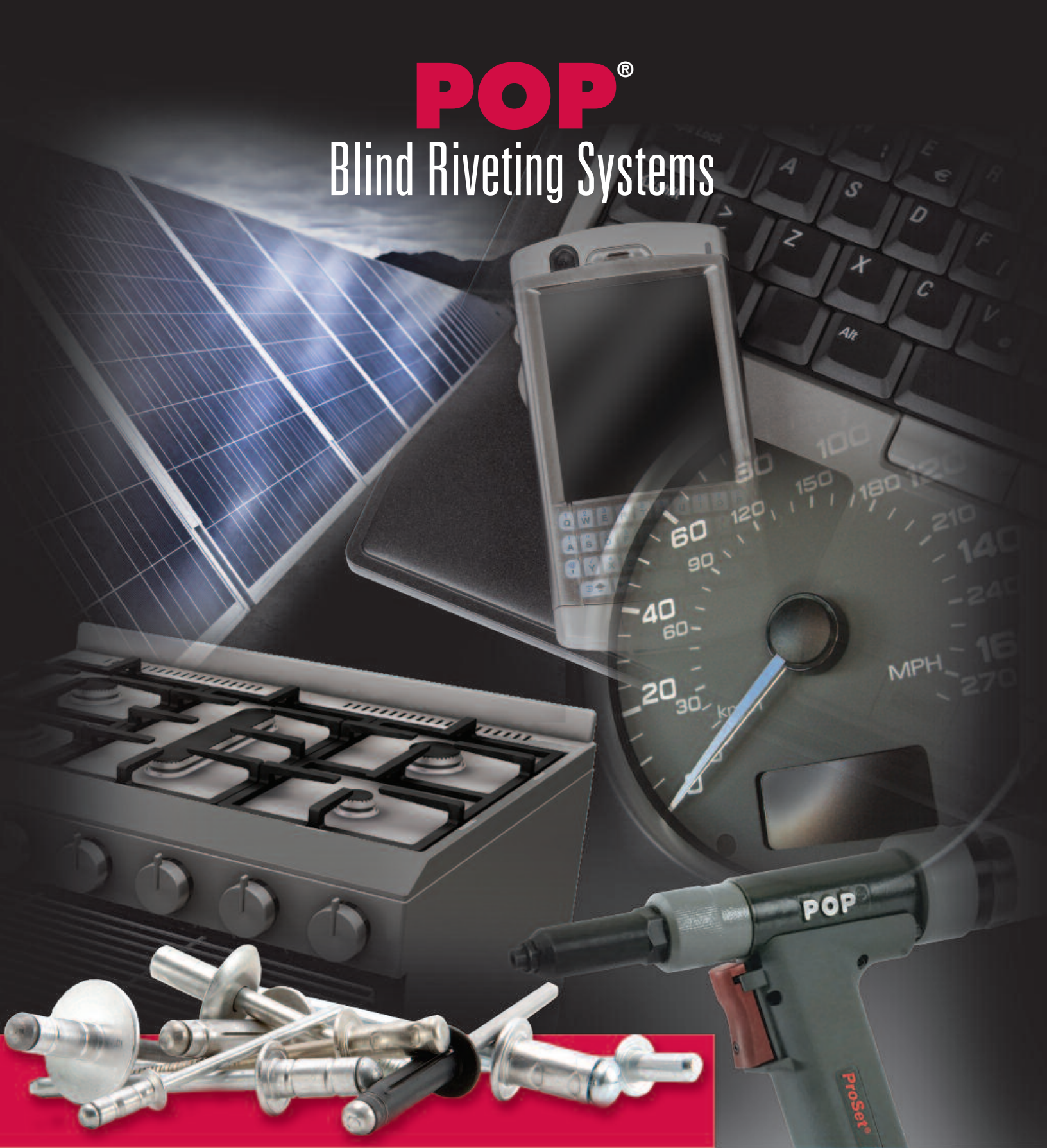

EMHART[®]
TEKNOLOGIES

emhartamericas.com



POP® Rivets

POP® Rivets have developed from their inception over 100 years ago and now include a vast range of high quality fasteners and setting tools that will meet the needs of your demanding manufacturing process.

The POP® range now includes soft setting rivets and rivets with superior clamping performance and grip range capabilities.

Available in Steel, Stainless Steel, Aluminium, Copper & Nickel Copper alloy, POP® Rivets have become the standard throughout the industry.

If it doesn't say POP®, it's not the original.

Hand Tools

The POPSet® Hand Tool range has been designed to offer the user the best features available in the market today.

These tools offer the quality, durability and reliability that is expected from Genuine POP® Rivet Tools.



Power Tools

POP® ProSet® rivet power tools set a new standard for pneumatic rivet tools.

With lightweight polymer construction and a high force-to-weight ratio, POP® ProSet® rivet tools keep your production lines running at full speed while reducing user fatigue. The POP® power tool range also includes MCS5800L Battery powered tool, MCS5250 In-Line tool and the PRG510 & 540 range of pneumatic tools.



Riveting Systems

POP® riveting systems are available to increase the efficiency of your production lines.

The range includes automatic rivet feeding, semi-automation, rivet set verification, multi-head riveting systems and rivet presenters.



Table of Contents

A Complete Range of Blind Riveting Products and Technical Information

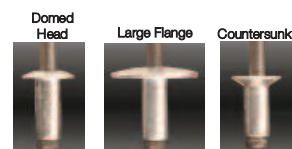

Body Style	Body Material	Mandrel Material	Head Style			Page
Open End	5052 Aluminum	Aluminum	●	●	●	14-16
	5056 Aluminum	Steel	●	●	●	16-19
	C1006-C1010 Steel	Steel	●	●	●	19-22
	300 Series Stainless Steel	Stainless Steel	●	●	●	23-24
	300 Series Stainless Steel	Steel	●	●	●	25-26
	110 Copper	Steel	●			27
	Nickel Copper Alloy	Steel	●		●	27-28
Easy Entry	5056 Aluminum	Steel	●	●		29
	C1006-C1010 Steel	Steel	●	●		29
Soft Set	1100 Aluminum	Aluminum	●		●	30
Micro	5154 Aluminum	Steel	●			31
Multi-Grip™	1100 Aluminum	Aluminum	●	●		32
	5052 Aluminum	Steel	●	●	●	33-34
	5052 Aluminum	Stainless Steel	●	●	●	34
	C1002-C1010 Steel	Steel	●	●		35
LS/LSR	5154 Aluminum	Aluminum	●	●		36
Closed End	1100 Aluminum	Aluminum	●			37
	5056 Aluminum	Steel	●	●	●	38-40
	5056 Aluminum	Stainless Steel	●			40
	300 Series Stainless Steel	Stainless Steel	●			41
	110 Copper	Steel	●			41
Pull-Thru (PT)	C1006-C1010 Steel	Steel			●	42
HS	C1002-C1010 Steel	Steel	●			43
	C1002-C1010 Aluminum	Aluminum	●			43
Grip Tite®/HR®	Carbon Steel	Steel	●	●	●	44
HR®	C1002-C1010 Stainless Steel	Stainless Steel	●		●	44-45
Self Plugger	C1006-C1010 Steel	Steel	●	●		46
T Rivets	5056 Aluminum	Steel	●	●		47
Ultra-Grip® (UG)	5056 Aluminum	Aluminum	●		●	48
	C1006-C1010 Steel	Steel	●	●	●	48-49
	300 Series Stainless Steel	Stainless Steel	●		●	50

Rivet Installation page 4
 Rivet Usage Guide page 5
 Rivet Types and Materials page 6-7
 Rivet Head Styles and Finishes page 8-9
 Design Guidelines page 10-12
 Troubleshooting Guide page 13
 Rivet Selection Guide page 14-50
 Tool Selection Guide page 51
 POP Manual Tools page 52-53
 POP Power Tools and Accessories page 54-60
 Nosepieces & Jaws page 61-63
 POP Automated Riveting Systems page 64-66

The POP® rivet installation sequence is simple.

1. Place the mandrel of the POP® rivet into the nosepiece of the setting tool.
2. Insert the POP® rivet body through the hole of the materials to be fastened.
3. Pull the trigger of the setting tool. The POP® Rivet body clamps the materials together and expands to form a secondary head on the blind side of the joint. The mandrel breaks at a pre-determined force.
4. The materials are now fastened together.



Rivet Usage Guide

The POP® rivet range has been designed to meet the needs of a wide variety of industry requirements.

The technical features and setting characteristics of each range are suitable for many different applications. An overview of typical rivet usage is shown here.

General Industry

- ✓ Low load bearing
- ✓ Multiple thicknesses
- ✓ Irregular holes



Open End
General purpose rivet



Multi-Grip™
General purpose Multi-Grip rivet accommodates a wide grip range

Automotive

- ✓ Multiple thicknesses
- ✓ Locked-in mandrel
- ✓ Composite materials
- ✓ Clamp-up



Multi-Grip™
General purpose Multi-Grip rivet accommodates a wide grip range



LS (Load Spreading)
Load spreading rivet ideal for use in vulnerable material

Appliance

- ✓ Water / Air tight
- ✓ Locked-in mandrel
- ✓ Wide blind side



Closed End
Water / pressure tight



Grip Tite®
Exceptional clamp-up and increased blind side expansion

Transport

- ✓ Improved strength
- ✓ Multiple thicknesses
- ✓ Clamp-up
- ✓ Locked-in mandrel



Ultra-Grip® (UG)
High shear and tensile strength with wide grip range capability



HS (High Strength)
1/4" (6.4mm) diameter rivet range with the strength of an 1/4" bolt

Electronics

- ✓ Low profile
- ✓ Multiple thicknesses



Pull-Thru (PT)
Sets flush on both sides of the application



Closed End
Mandrel head retention

Construction

- ✓ Wood to metal
- ✓ Locked-in mandrel
- ✓ Improved strength



HS (High Strength)
1/4" (6.4mm) diameter rivet range with the strength of an 1/4" bolt



Ultra-Grip® (UG)
High shear and tensile strength with wide grip range capability

Rivet Types



Open End

General purpose rivet available in a wide range of materials and head styles. Suitable for applications with normal load bearing requirements.

Easy Entry

Easy Entry rivets line up odd shaped or misaligned holes in multiple sheets of material to make production easier and faster.

Soft Set

Soft-Set rivets incorporate a body and mandrel made from special aluminum alloys and are designed for soft or brittle materials.

Micro

With a 2.0mm diameter and a low head height for tight spaces and low secondary side protrusion, the Micro rivet is ideal for PCB's and thin sheet metal applications. Widely used in electronics applications.

Multi-Grip™

The Multi-Grip rivet is designed to accommodate a wider grip range than other rivets allowing for lower inventory levels. Provides good rattle free, vibration resistant joint construction even in irregular holes.

LS/LSR (Load Spreading Rivet)

Load spreading characteristics make this rivet ideal for use in vulnerable, friable and very soft materials.

Closed End

Designed with a completely closed body, this rivet is ideal for applications that need to be water/pressure tight or where mandrel retention is paramount.

Pull-Thru (PT)

The Pull-Thru (PT) is a countersunk rivet ideal for low clearance applications and features a 'double flush' set on both sides of the application. With the unique patented pull-thru design, no mandrel heads will remain anywhere in the application making them ideal in electronics applications.

HS (High Strength)

High Strength rivets with large blind side expansion for structural applications. With excellent shear and tensile, also provides vibration resistance and enhances joint integrity.

Grip Tite® & HR®

Exceptional clamp-up capability and increased blind side expansion give the perfect combination for overcoming air gaps while expanding the load during setting. Excellent mandrel retention and rattle resistance after setting.

Self Plugger

This rattle resistant rivet offers positive mandrel head retention with mandrel gripping rings; mandrel remains in shear plain for optimum strength and is automation friendly.

T-Rivet

Ideal for joining softer and more brittle materials such as plastic, rubber or wood with the added benefit of clamp-up. Improved shear strength is also achieved due to the mandrel head retention after setting.

Ultra-Grip® (UG)

These high strength rivets with a positive mechanical locking system provide superior holding power. The locking feature seals the mandrel head into the body preventing head drop out keeping the application free from contamination. UG rivets offer superior shear and tensile properties in structural applications.

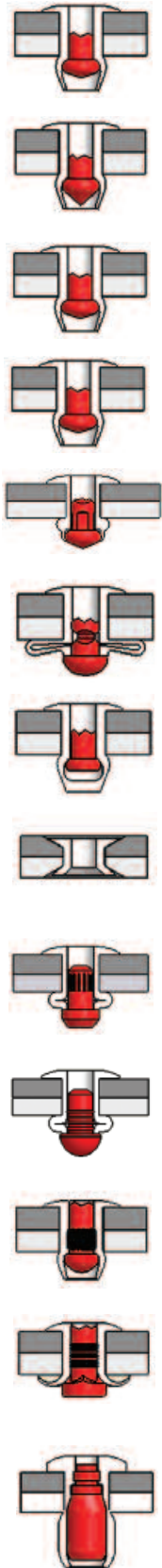

Rivet Materials

POP® Rivets are available in Steel, Stainless Steel, Nickel Copper Alloy (Monel) Copper and several grades of Aluminum to meet the requirements of a wide variety of applications.

Rivet Material Selection

Generally the rivet selected should have the same physical and mechanical properties as the components to be joined.



Aluminum – 1100

**Commercially pure aluminum for extremely soft or brittle materials;
for lower shear/tensile requirements**

Aluminum – 5052

**Best used where higher shear & tensile is required;
good corrosion resistance**

Aluminum – 5056

**Best used where higher shear & tensile is required;
good corrosion resistance**

Aluminum – 5154

Used for special products/applications

Steel – C1002-C1010

General purpose use; used for all steel rivet mandrels

Stainless Steel – 300 Series

Austenitic stainless steel; offers good corrosion resistance

Nickel Copper Alloy – 400

**Offers extremely high corrosion resistance; has excellent
elevated temperature properties**

Copper – 110

Used where electrical conductivity is required

Rivet Head Styles

Head Styles

POP® Rivets are available with the following flange configurations:



Domed Head

Standard low profile head, suitable for most applications.



Large Flange

For use where thin, brittle, soft or vulnerable materials are fastened. Provides large bearing surface on primary side and ideal for covering enlarged holes or slots.



Countersunk

With a 120° head design, used wherever a flush surface is required.

Customer Specific Solutions*

We support the design and application needs of our customers through highly skilled and experienced application and design engineers.

If you require a rivet with a special feature or if you need advice as to the best solution for your application please contact Emhart Customer Service with the following application details:

- Application description
- Materials to be fastened - material types, thicknesses
- Hole sizes
- Annual volume
- Extraordinary fastener requirements

* Subject to minimum order quantities

Typical Customer Specific Design Solutions:



Extended Length Grooved Mandrel



Collar Assembly



Plastic Cap Rivet

Rivet Finishes

Finishes

POP® Rivets in Steel are supplied with Zinc and Clear passivation as standard. Steel, Stainless Steel and Copper components all meet the RoHS directive and are mercury free.

POP® Rivets in Nickel Copper are supplied zinc plated.

There are a wide variety of other finishes also available for aesthetic and environmental needs including:- Xylan, Anodization & Zinc Nickel.



We offer the complete color palette of paint finishes.

We can also match your application to a paint color if required. Please contact Emhart Customer Service.

Special finishes are subject to minimum order quantities.

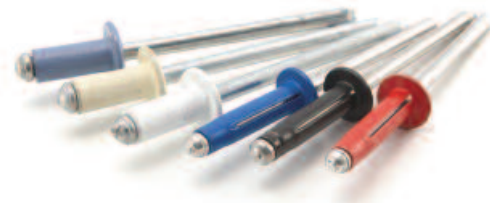

Corrosion Resistance & Steel Rivet Finishes

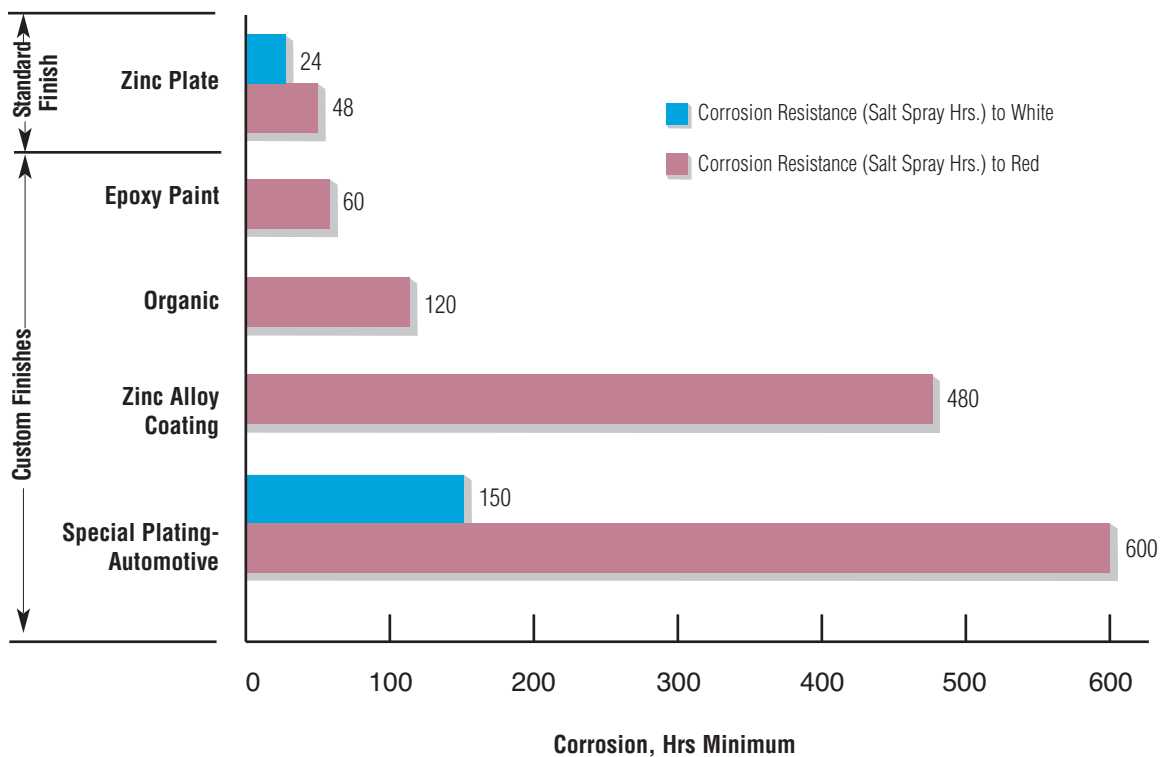

Note: Typical values for steel plates rivets tested in accordance with ASTM B117

Design Guidelines

These illustrations provide a graphic representation of the rivet selection factors to be considered and described in greater detail in the accompanying text.

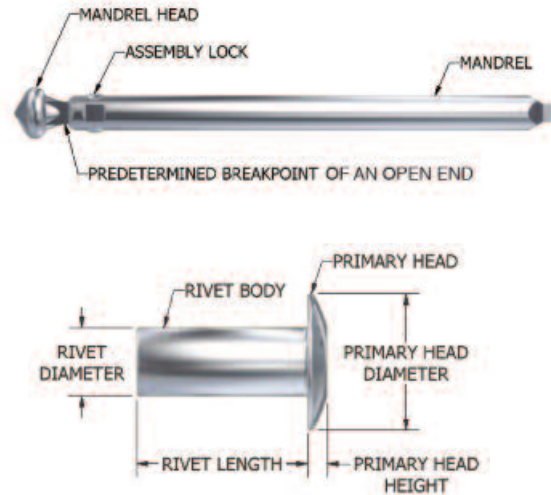
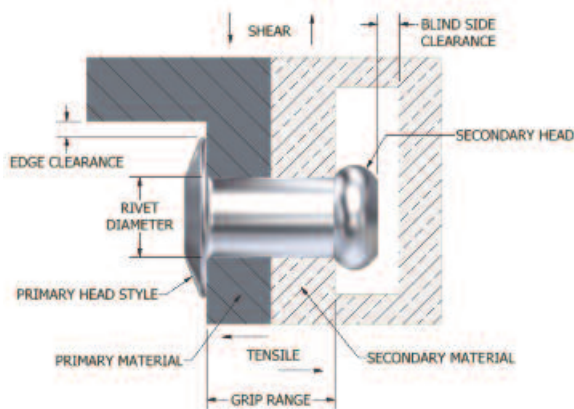

Rivet Terminology/Nomenclature

1. Hole size

Hole size can be important in blind riveting. Too small a hole will, of course, make rivet insertion difficult. Too large a hole will reduce the shear and tensile strengths. It may also cause bulging or separation of the members by allowing the rivet to expand between them instead of only on the blind side. (Best practice is to follow the hole size recommendations provided). Avoid burrs in and around the holes.

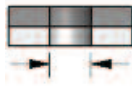

2. Grip Range

The recommended thickness range over which the body length will consistently provide a proper setting in a hole of the specified diameter.

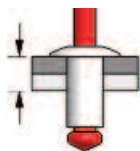

3. Shear

The load applied to a fastener along the joint interface.

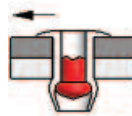

4. Tensile

The load applied to a fastener along its length.

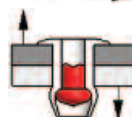

5. Joint strength

First determine the single-joint tensile and shear values required for the application. These are functions of total joint strength, fastener spacing, rivet body material and rivet diameter. Then refer to the "Shear" and "Tensile" in the Rivet Selection Guide (pp14-50) on the product, and select a POP brand rivet that provides the values required. POP brand rivets are not certified for structural aerospace applications and such use is not recommended.

6. Joint thickness

Measure the total thickness of the materials to be joined. This determines the required "grip" of the rivet you select. Refer to the "Grip Range" in the Rivet Selection Guide (pp14-50) and select a rivet with a grip range that includes the work thickness required. Remember that insufficient rivet length will not allow proper formation of the secondary head at the back of the work.

7. Nature of materials

Both the rivet and the materials to be fastened will affect the ultimate joint strength. As a rule, the rivet materials should have the same physical and mechanical properties as the materials to be fastened, because a marked dissimilarity may cause joint failure due either to material fatigue or galvanic corrosion.

8. Head Style

The low-profile domed head is appropriate for most applications. However, when soft or brittle materials are fastened to a rigid backing member, the large flange head should be considered because it offers twice the bearing surface. Where a flush surface is required, the countersunk head style should be selected.



Design Guidelines

The material that follows will provide a useful planning guide for most applications. In addition, we offer the services of our engineering staff to help with unusual requirements.

Some of the variables to consider are:

- Joint type, configuration, thickness and material
- Hole size
- Tool access
- Rivet size, material and spacing
- Tightness of clamp
- Hole type

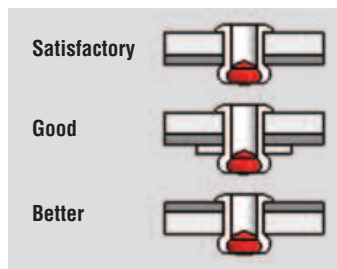

Thin & Thick Assembling

Wherever possible, set the secondary head against the thicker and therefore stronger material.

Where the head must be set against the thinner material, consider using the POP HR or HS rivet or a backup washer when using Open End rivets. POP brand open end rivets are successfully set against aluminum stock as thin as .020".

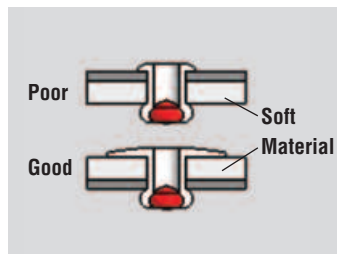

Fastening Soft to Hard

Soft-to-hard materials are sometimes assembled by using a backup washer and forming the secondary head against the soft material. It is best to use a Large Flange rivet and set the secondary head against the hard material. Whenever this is not possible, consider using POP LSR rivets.

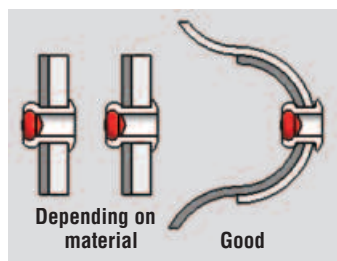

Plastics and Brittle Materials

Where the more fragile plastics are involved, POP Soft-Set or LSR rivets should be specified. Where the plastic is rigid enough to afford satisfactory clamping action, standard POP open end brand rivets can be set directly against plastics as shown here.

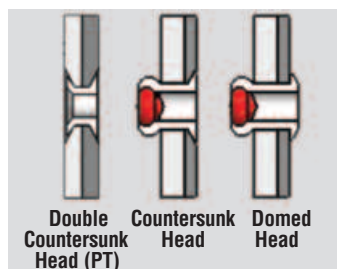

Head Clearance

Height and diameter of domed head rivets should be checked against specifications where no projection is permitted; rivets with 120° countersunk head style afford a truly flush surface. For a double flush set, use the POP Pull-Thru (PT) rivets.

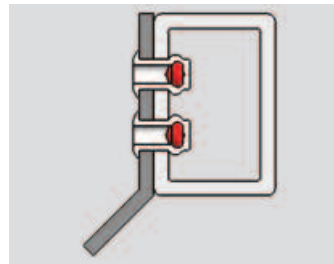

Fully Sealed Fastening

POP Closed End Rivets should be specified for all of the many applications where a fully sealed fastening is essential. This rivet design produces a seal that prevents passage of liquid or vapor at pressures up to 100 psi.

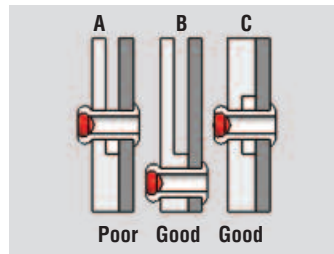

Tight Joints

Because POP Rivets exert a high gripping force when clamped, the joint shown in **A** would be unsatisfactory. The methods shown in **B** and **C** are better ways to handle the same assembly problem. For improved clamp-up force, consider using POP Ultra-Grip or HS rivets.

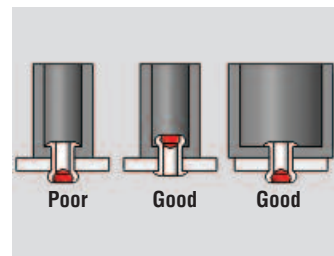

Channel Sections

Where narrow channels must be assembled, check clearance for adequate tool width. Alternately, set rivet from the underside – or widen the channel section – or use one of the available POP Rivet tool nosepiece extensions that can add up to an inch in length. In this case, a rivet with a larger mandrel is required.

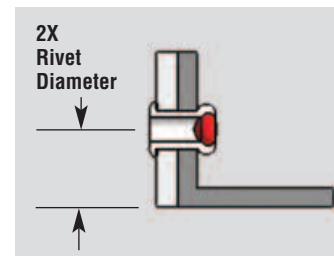

Edge Clearance

For maximum joint strength, the distances from the rivet centerline to the edge of a sheet should not be less than twice the rivet diameter. Where joint strength is not critical, this dimension can be reduced.

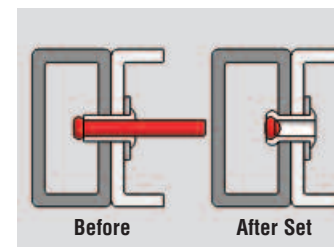

Blind Side Clearance

This is the distance from the underside of the rivet head to the end of the mandrel before setting minus the combined thickness of the materials being fastened. Design must permit enough blind side clearance to allow a fully formed secondary head when setting the rivet. Consider using POP Pull-Thru rivets where clearance is a concern.

Design Guidelines

Galvanic Corrosion

Galvanic corrosion occurs when two dissimilar metals are in contact in the presence of an electrolyte, which is a medium through which an electrical current can flow (i.e. moisture). The rate of corrosion depends upon the amount and concentration of the electrolyte as well as the difference in electrical potential (anodic-cathodic relationship) of the metals as shown in the Galvanic Series Chart to the right.

A highly anodic material in contact with a highly cathodic material will corrode much more quickly than two highly cathodic materials or when the materials used are closer together in the Galvanic Series Chart.

When corrosion does occur, the anodic material is the most likely to corrode, whereas the cathodic material is the least likely to corrode. To reduce the likelihood of galvanic corrosion in a fastened joint, it's recommended to choose materials that are grouped together in the Galvanic Series Chart. Recommendations include:

- 1) Select materials that are as close together as possible in the Galvanic Series Chart
- 2) Provide a barrier between the two metals, such as paint, non-metallic washer or gaskets
- 3) Design the fastener as the cathode so the cathodic area is small as compared to the anodic area
- 4) Use a metallic finish on the fastener that is close on the chart to the mating material

Typical Setting Cycle for an Open Rivet

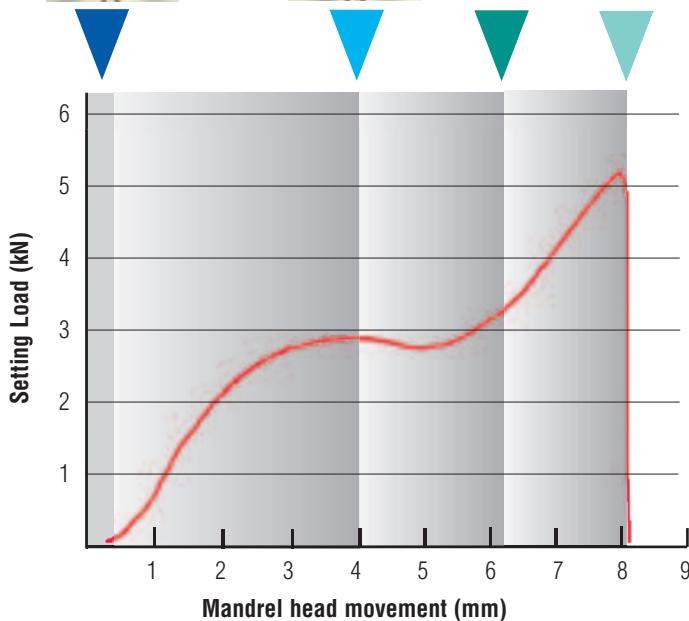

- 1 The rivet is placed into the holes of the work piece
- 2 The setting tool applies a load to the mandrel and the mandrel head starts to enter the rivet body
- 3 Continued pulling of the mandrel causes the rivet body to expand, clamping the work piece plates
- 4 The pulling load gradually increases until the plates are clamped firmly together and, at a predetermined setting load, the mandrel breaks

Corroded End (Anodic, Least Noble)	↑
Magnesium	
Magnesium Alloys	
Zinc	
Aluminum 1100	
Cadmium	
Aluminum 2024-T4	
Steel or Iron	
Cast Iron	
Chromium-Iron (active)	
Ni-Resist Cast Iron	
Type 304 Stainless (active)	
Type 316 Stainless (active)	
Lead-Tin Solders	
Lead	
Tin	
Nickel (active)	
Inconel Nickel-Chromium Alloy (active)	
Hastelloy Alloy C (active)	
Brasses	
Copper	
Bronzes	
Copper-Nickel Alloy	
Monel Nickel-Copper Alloy	
Silver Solder	
Nickel (passive)	
Inconel Nickel-Chromium Alloy (passive)	
Chromium-Iron (passive)	
Type 304 Stainless Steel (passive)	
Type 316 Stainless Steel (passive)	
Hastelloy Alloy C (passive)	
Silver	
Titanium	
Graphite	
Gold	
Platinum	
Protected End (Cathodic, Most Noble)	↓

Trouble Shooting Guide

Description of Typical Potential Problems

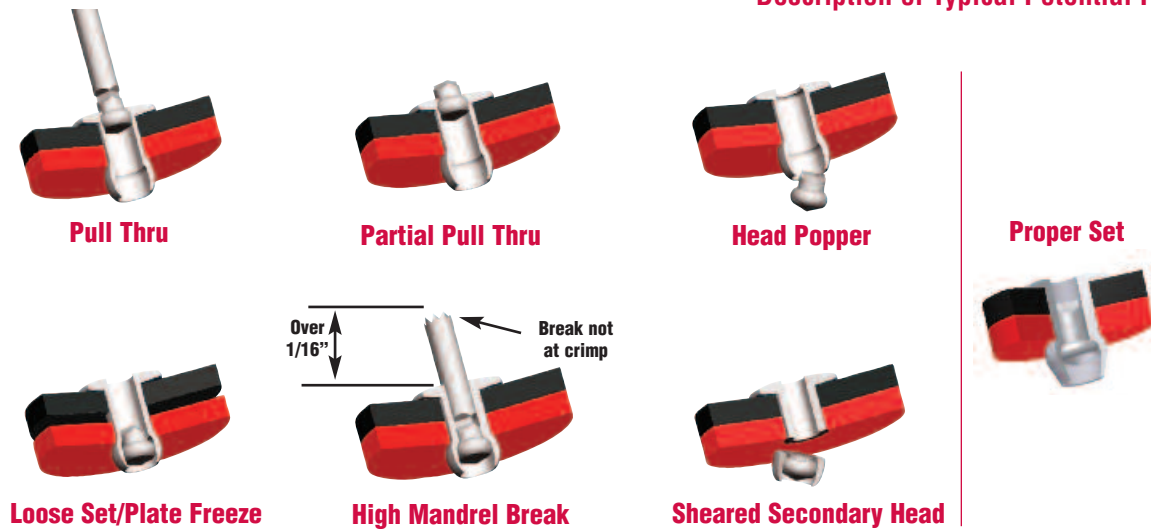

Potential Cause	Problem Type						
	Pull Thru	Partial Pull Thru	Head Popper	Loose Set	Plate Freeze	High Mandrel Break	Sheared Secondary Head
Over maximum recommended hole	APPLICABLE	APPLICABLE	NOT APPLICABLE	NOT APPLICABLE	NOT APPLICABLE	NOT APPLICABLE	NOT APPLICABLE
Under minimum recommended hole	NOT APPLICABLE	NOT APPLICABLE	APPLICABLE	APPLICABLE	NOT APPLICABLE	APPLICABLE	APPLICABLE
Grip thickness over maximum	NOT APPLICABLE	NOT APPLICABLE	APPLICABLE	APPLICABLE	NOT APPLICABLE	NOT APPLICABLE	APPLICABLE
Grip thickness under minimum	APPLICABLE	NOT APPLICABLE	NOT APPLICABLE	APPLICABLE	NOT APPLICABLE	APPLICABLE	NOT APPLICABLE
Improper Hole Condition							
Excessive variation in size	APPLICABLE	APPLICABLE	APPLICABLE	APPLICABLE	NOT APPLICABLE	APPLICABLE	APPLICABLE
Noncircular hole	APPLICABLE	APPLICABLE	APPLICABLE	APPLICABLE	NOT APPLICABLE	NOT APPLICABLE	APPLICABLE
Tapered hole	APPLICABLE	APPLICABLE	APPLICABLE	APPLICABLE	NOT APPLICABLE	NOT APPLICABLE	APPLICABLE
Burrs and sharp edges	APPLICABLE	APPLICABLE	APPLICABLE	APPLICABLE	NOT APPLICABLE	NOT APPLICABLE	APPLICABLE
Applicable material too soft	APPLICABLE	APPLICABLE	APPLICABLE	NOT APPLICABLE	NOT APPLICABLE	NOT APPLICABLE	NOT APPLICABLE
Non-perpendicular set (improper alignment of tooling to application)	APPLICABLE	APPLICABLE	APPLICABLE	APPLICABLE	APPLICABLE	APPLICABLE	APPLICABLE
Wrong nosepiece on tooling	APPLICABLE	APPLICABLE	APPLICABLE	APPLICABLE	NOT APPLICABLE	NOT APPLICABLE	NOT APPLICABLE
Gap between material thicknesses	APPLICABLE	APPLICABLE	APPLICABLE	APPLICABLE	APPLICABLE	NOT APPLICABLE	NOT APPLICABLE
Insufficient secondary side clearance	NOT APPLICABLE	NOT APPLICABLE	NOT APPLICABLE	APPLICABLE	APPLICABLE	NOT APPLICABLE	NOT APPLICABLE

= APPLICABLE
 = NOT APPLICABLE

Refer to Rivet Selection Guide for proper design conditions. If you need further assistance, contact our application engineers and be prepared to supply the following information and samples.

- | | | |
|--|--|--|
| <ul style="list-style-type: none"> • Company Name / Contact Name • Address / Tel. # / Fax # / EMail • Sales representative or Distributor • Frequency of failure | <ul style="list-style-type: none"> • Rivet part number • Affected quantities • Affected lot numbers • Hole sizes (tolerances) • Grip thickness (ranges) | <ul style="list-style-type: none"> • Tooling information • Tooling nosepiece • 50 unset rivets for tests • Samples of failed rivets • Sample of application |
|--|--|--|



Nominal Rivet Diameter	(L) Nominal Rivet Body Length	(F) Nominal Blind Side Protrusion	Grip Range	Rivet Part Number	Hole Size	Dimensions				Shear Strength	Tensile Strength
						(D) Body Diameter	(H) Flange Thickness	(E) Flange Diameter	(W) Nominal Mandrel Diameter		
In. (mm)	In. (mm)	In. (mm)	In. (mm)		In. (mm)	In. (mm)	In. (mm)	In. (mm)	In. (mm)	Lbs. (N)	Lbs. (N)
5052 Aluminum Body/Aluminum Mandrel – Domed Head – Finish: Plain/Plain											
3/32 (2.4)	.225 (5.7)	.325 (8.3)	.032-.125 (.8-3.2)	AD 32 ABS	.097-.100 (2.46-2.54)	.092-.096 (2.34-2.44)	.024-.032 (0.61-0.81)	.178-.198 (4.52-5.03)	.057 (1.45)	85 (378)	135 (600)
	.350 (8.9)	.450 (11.4)	.126-.250 (3.2-6.4)	AD 34 ABS							
	.475 (12.1)	.575 (14.6)	.251-.375 (6.4-9.5)	AD 36 ABS							
1/8 (3.2)	.188 (4.8)	.308 (7.8)	.032-.062 (.8-1.6)	AD 41 ABS	.129-.133 (3.28-3.38)	.122-.128 (3.10-3.25)	.032-.040 (0.81-1.02)	.238-.262 (6.05-6.66)	.076 (1.93)	155 (689)	235 (1045)
	.250 (6.4)	.370 (9.4)	.063-.125 (1.6-3.2)	AD 42 ABS							
	.313 (8.0)	.433 (11.0)	.126-.187 (3.2-4.8)	AD 43 ABS							
	.375 (9.5)	.495 (12.6)	.188-.250 (4.8-6.4)	AD 44 ABS							
	.438 (11.1)	.558 (14.2)	.251-.312 (6.4-7.9)	AD 45 ABS							
	.500 (12.7)	.620 (15.7)	.313-.375 (7.9-9.5)	AD 46 ABS							
	.625 (15.9)	.745 (18.9)	.376-.500 (9.5-12.7)	AD 48 ABS							
	.750 (19.1)	.870 (22.1)	.501-.625 (12.7-15.9)	AD 410 ABS							
5/32 (4.0)	.275 (7.0)	.415 (10.5)	.063-.125 (1.6-3.2)	AD 52 ABS	.160-.164 (4.06-4.17)	.153-.159 (3.89-4.04)	.039-.047 (.99-1.11)	.296-.328 (7.52-8.33)	.095 (2.41)	225 (1000)	350 (1556)
	.338 (8.6)	.478 (12.1)	.126-.187 (3.2-4.8)	AD 53 ABS							
	.400 (10.2)	.540 (13.7)	.188-.250 (4.8-6.4)	AD 54 ABS							
	.525 (13.3)	.665 (16.9)	.251-.375 (6.4-9.5)	AD 56 ABS							
	.650 (16.5)	.790 (20.1)	.376-.500 (9.5-12.7)	AD 58 ABS							
	.775 (19.7)	.915 (23.2)	.501-.625 (12.7-15.9)	AD 510 ABS							
3/16 (4.8)	.300 (7.6)	.460 (11.7)	.063-.125 (1.6-3.2)	AD 62 ABS	.192-.196 (4.88-4.98)	.183-.191 (4.65-4.85)	.047-.055 (1.19-1.40)	.357-.393 (9.07-9.98)	.114 (2.90)	315 (1401)	500 (2224)
	.425 (10.8)	.585 (14.9)	.126-.250 (3.2-6.4)	AD 64 ABS							
	.550 (14.0)	.710 (18.0)	.251-.375 (6.4-9.5)	AD 66 ABS							
	.675 (17.2)	.835 (21.2)	.376-.500 (9.5-12.7)	AD 68 ABS							
	.800 (20.3)	.960 (24.4)	.501-.625 (12.7-15.9)	AD 610 ABS							
	.925 (23.5)	1.085 (27.6)	.626-.750 (15.9-19.1)	AD 612 ABS							
	1.051 (26.7)	1.210 (30.7)	.751-.875 (19.1-22.2)	AD 614 ABS							
	1.175 (29.9)	1.335 (33.9)	.876-1.00 (22.2-25.4)	AD 616 ABS							



POP® Open End Rivets

Nominal Rivet Diameter	(L) Nominal Rivet Body Length	(F) Nominal Blind Side Protrusion	 Grip Range	Rivet Part Number	 Hole Size					 Shear Strength	 Tensile Strength
						(D) Body Diameter	(H) Flange Thickness	(E) Flange Diameter	(W) Nominal Mandrel Diameter		
In. (mm)	In. (mm)	In. (mm)	In. (mm)		In. (mm)	In. (mm)	In. (mm)	In. (mm)	In. (mm)	Lbs. (N)	Lbs. (N)
5052 Aluminum Body/Aluminum Mandrel – Domed Head – Finish: Plain/Plain											
1/4 (6.4)	.350 (8.9)	.585 (14.9)	.062-.125 (1.6-3.2)	AD 82 ABS	.257-.261 (6.53-6.63)	.249-.255 (6.32-6.48)	.065-.073 (1.65-1.85)	.475-.525 (12.06-13.34)	.151 (3.84)	600 (2669)	750 (3336)
	.475 (12.1)	.710 (18.0)	.126-.250 (3.2-6.4)	AD 84 ABS							
	.600 (15.2)	.835 (21.2)	.251-.375 (6.4-9.5)	AD 86 ABS							
	.725 (18.4)	.960 (24.4)	.376-.500 (9.5-12.7)	AD 88 ABS							
	.850 (21.6)	1.085 (27.6)	.501-.625 (12.7-15.9)	AD 810 ABS							
	.975 (24.8)	1.210 (30.7)	.626-.750 (15.9-19.1)	AD 812 ABS							
	1.100 (27.9)	1.335 (33.9)	.751-.875 (19.1-22.2)	AD 814 ABS							
	1.225 (31.1)	1.460 (37.1)	.876-1.00 (22.2-25.4)	AD 816 ABS							
5052 Aluminum Body/Aluminum Mandrel – Large Flange – Finish: Plain/Plain											
1/8 (3.2)	.250 (6.4)	.370 (9.4)	.063-.125 (1.6-3.2)	AD 42 ABS LF	.129-.133 (3.28-3.38)	.122-.128 (3.10-3.25)	.034-.046 (0.86-1.17)	.360-.390 (9.14-9.91)	.076 (1.93)	155 (689)	235 (1045)
	.313 (7.9)	.433 (11.0)	.126-.187 (3.2-4.8)	AD 43 ABS LF							
	.375 (9.5)	.495 (12.6)	.188-.250 (4.8-6.4)	AD 44 ABS LF							
	.500 (12.7)	.620 (15.7)	.313-.375 (7.9-9.5)	AD 46 ABS LF							
5/32 (4.0)	.400 (10.2)	.540 (13.7)	.188-.250 (4.8-6.4)	AD 54 ABS LF	.160-.164 (4.06-4.17)	.153-.159 (3.89-4.04)	.042-.056 (1.07-1.42)	.448-.488 (11.38-12.40)	.095 (2.41)	225 (1000)	350 (1556)
	.525 (13.3)	.665 (16.9)	.251-.375 (6.4-9.5)	AD 56 ABS LF							
	.650 (16.5)	.790 (20.1)	.376-.500 (9.5-12.7)	AD 58 ABS LF							
3/16 (4.8)	.425 (10.8)	.585 (14.9)	.126-.250 (3.2-6.4)	AD 64 ABS LF	.192-.196 (4.88-4.98)	.183-.191 (4.65-4.85)	.067-.083 (1.70-2.11)	.600-.650 (15.24-16.51)	.114 (2.90)	315 (1401)	500 (2224)
	.550 (14.0)	.710 (18.0)	.251-.375 (6.4-9.5)	AD 66 ABS LF							
	.675 (17.1)	.835 (21.2)	.376-.500 (9.5-12.7)	AD 68 ABS LF							
	.800 (20.3)	.960 (24.4)	.501-.625 (12.7-15.9)	AD 610 ABS LF							
	.925 (23.5)	1.085 (27.6)	.626-.750 (15.9-19.1)	AD 612 ABS LF							
	1.175 (29.8)	1.335 (33.9)	.876-1.000 (22.2-25.4)	AD 616 ABS LF							



Nominal Rivet Diameter	(L) Nominal Rivet Body Length	(F) Nominal Blind Side Protrusion	Grip Range	Rivet Part Number	Hole Size	Rivet Dimensions				Shear Strength	Tensile Strength
						(D) Body Diameter	(H) Flange Thickness	(E) Flange Diameter	(W) Nominal Mandrel Diameter		
In. (mm)	In. (mm)	In. (mm)	In. (mm)		In. (mm)	In. (mm)	In. (mm)	In. (mm)	In. (mm)	Lbs. (N)	Lbs. (N)
5052 Aluminum Body/Aluminum Mandrel – 120° Countersunk – Finish: Plain/Plain											
1/8 (3.2)	.250 (6.4)	.370 (9.4)	.063-.125 (1.6-3.2)	AK 42 ABS	.129-.133 (3.28-3.38)	.122-.128 (3.10-3.25)	.051 Max (1.30)	.207-.233 (5.26-5.92)	.076 (1.93)	155 (689)	235 (1045)
	.313 (8.0)	.433 (11.0)	.126-.187 (3.2-4.8)	AK 43 ABS							
	.375 (9.5)	.495 (12.6)	.188-.250 (4.8-6.4)	AK 44 ABS							
	.438 (11.1)	.558 (14.2)	.251-.312 (6.4-7.9)	AK 45 ABS							
	.500 (12.7)	.620 (15.7)	.313-.375 (7.9-9.5)	AK 46 ABS							
	.750 (19.1)	.870 (22.1)	.501-.625 (12.7-15.9)	AK 410 ABS							
5/32 (4.0)	.275 (7.0)	.415 (10.5)	.063-.125 (1.6-3.2)	AK 52 ABS	.160-.164 (4.06-4.17)	.153-.159 (3.89-4.04)	.063 Max (1.60)	.266-.296 (6.76-7.52)	.095 (2.41)	225 (1000)	350 (1556)
	.400 (10.2)	.540 (13.7)	.188-.250 (4.8-6.4)	AK 54 ABS							
	.525 (13.3)	.665 (16.9)	.313-.375 (7.9-9.5)	AK 56 ABS							
3/16 (4.8)	1.175 (29.9)	1.335 (33.9)	.876-1.00 (22.2-25.4)	AK 616 ABS	.192-.196 (4.88-4.98)	.183-.191 (4.65-4.85)	.071 Max (1.80)	.333-.363 (8.46-9.22)	.114 (2.90)	315 (1401)	500 (2224)
5056 Aluminum Body/Steel Mandrel – Domed Head – Finish: Plain/Protective Coating											
3/32 (2.4)	.225 (5.7)	.325 (8.3)	.031-.125 (.8-3.2)	AD 32 BS	.097-.100 (2.46-2.54)	.092-.096 (2.34-2.44)	.024-.032 (0.61-0.81)	.178-.198 (4.52-5.03)	.057 (1.45)	125 (378)	175 (778)
	.350 (8.9)	.450 (11.4)	.126-.250 (3.2-6.4)	AD 34 BS							
1/8 (3.2)	.188 (4.8)	.308 (7.8)	.032-.062 (.8-1.6)	AD 41 BS	.129-.133 (3.28-3.38)	.122-.128 (3.10-3.25)	.032-.040 (.081-1.02)	.238-.262 (6.05-6.66)	.076 (1.93)	210 (934)	325 (1445)
	.250 (6.5)	.370 (9.4)	.063-.125 (1.6-3.2)	AD 42 BS							
	.313 (8.0)	.433 (11.0)	.126-.187 (3.2-4.8)	AD 43 BS							
	.375 (9.5)	.495 (12.6)	.188-.250 (4.8-6.4)	AD 44 BS							
	.438 (11.1)	.558 (14.2)	.251-.312 (6.4-7.9)	AD 45 BS							
	.500 (12.7)	.620 (15.7)	.313-.375 (7.9-9.5)	AD 46 BS							
	.625 (15.9)	.745 (18.9)	.376-.500 (9.5-12.7)	AD 48 BS							
.750 (19.1)	.870 (22.1)	.501-.625 (12.7-15.9)	AD 410 BS								



POP® Open End Rivets

Nominal Rivet Diameter	(L) Nominal Rivet Body Length	(F) Nominal Blind Side Protrusion	Grip Range	Rivet Part Number	Hole Size	Rivet Dimensions				Shear Strength	Tensile Strength
						(D) Body Diameter	(H) Flange Thickness	(E) Flange Diameter	(W) Nominal Mandrel Diameter		
In. (mm)	In. (mm)	In. (mm)	In. (mm)		In. (mm)	In. (mm)	In. (mm)	In. (mm)	In. (mm)	Lbs. (N)	Lbs. (N)
5056 Aluminum Body/Steel Mandrel – Domed Head – Finish: Plain/Protective Coating											
5/32 <i>(4.0)</i>	.275 <i>(7.0)</i>	.415 <i>(10.5)</i>	.063-.125 <i>(1.6-3.2)</i>	AD 52 BS	.160-.164 <i>(4.06-4.17)</i>	.153-.159 <i>(3.89-4.04)</i>	.039-.047 <i>(0.99-1.19)</i>	.296-.328 <i>(7.52-8.33)</i>	.095 <i>(2.41)</i>	340 <i>(1512)</i>	490 <i>(2179)</i>
	.338 <i>(8.6)</i>	.478 <i>(12.1)</i>	.126-.187 <i>(3.2-4.8)</i>	AD 53 BS							
	.400 <i>(10.2)</i>	.540 <i>(13.7)</i>	.188-.250 <i>(4.8-6.4)</i>	AD 54 BS							
	.525 <i>(13.3)</i>	.665 <i>(16.9)</i>	.251-.375 <i>(6.4-9.5)</i>	AD 56 BS							
	.650 <i>(16.5)</i>	.790 <i>(20.1)</i>	.376-.500 <i>(9.5-12.7)</i>	AD 58 BS							
3/16 <i>(4.8)</i>	.300 <i>(7.6)</i>	.460 <i>(11.7)</i>	.063-.125 <i>(1.6-3.2)</i>	AD 62 BS	.192-.196 <i>(4.88-4.98)</i>	.183-.191 <i>(4.65-4.85)</i>	.047-.055 <i>(1.19-1.4)</i>	.357-.393 <i>(9.07-9.98)</i>	.114 <i>(2.90)</i>	445 <i>(1979)</i>	720 <i>(3202)</i>
	.425 <i>(10.8)</i>	.585 <i>(14.9)</i>	.126-.250 <i>(3.2-6.4)</i>	AD 64 BS							
	.550 <i>(14.0)</i>	.710 <i>(18.0)</i>	.251-.375 <i>(6.4-9.5)</i>	AD 66 BS							
	.675 <i>(17.2)</i>	.835 <i>(21.2)</i>	.376-.500 <i>(9.5-12.7)</i>	AD 68 BS							
	.800 <i>(20.3)</i>	.960 <i>(24.4)</i>	.501-.625 <i>(12.7-15.9)</i>	AD 610 BS							
	.925 <i>(23.5)</i>	1.085 <i>(27.6)</i>	.626-.750 <i>(15.9-19.1)</i>	AD 612 BS							
	1.05 <i>(26.7)</i>	1.210 <i>(30.7)</i>	.751-.875 <i>(19.1-22.2)</i>	AD 614 BS							
	1.175 <i>(29.9)</i>	1.335 <i>(33.9)</i>	.876-1.00 <i>(22.2-25.4)</i>	AD 616 BS							
	1.30 <i>(33.0)</i>	1.46 <i>(37.1)</i>	1.001-1.125 <i>(25.4-28.6)</i>	AD 618 BS							
1/4 <i>(6.4)</i>	.475 <i>(12.1)</i>	.710 <i>(18.0)</i>	.063-.250 <i>(1.6-6.4)</i>	AD 84 BS	.257-.261 <i>(6.53-6.63)</i>	.249-.255 <i>(6.32-6.48)</i>	.065-.073 <i>(1.65-1.85)</i>	.475-.525 <i>(12.06-13.34)</i>	.151 <i>(3.84)</i>	890 <i>(3958)</i>	1200 <i>(5337)</i>
	.600 <i>(15.2)</i>	.835 <i>(21.2)</i>	.251-.375 <i>(6.4-9.5)</i>	AD 86 BS							
	.725 <i>(18.4)</i>	.960 <i>(24.4)</i>	.376-.500 <i>(9.5-12.7)</i>	AD 88 BS							
	.850 <i>(21.6)</i>	1.085 <i>(27.6)</i>	.501-.625 <i>(12.7-15.9)</i>	AD 810 BS							
	.975 <i>(24.8)</i>	1.210 <i>(30.7)</i>	.626-.750 <i>(15.9-19.1)</i>	AD 812 BS							
	1.225 <i>(31.1)</i>	1.460 <i>(37.1)</i>	.876-1.00 <i>(22.2-25.4)</i>	AD 816 BS							



**POP® Brand Rivets
In
Hearth, Grill and
Patio Applications**





Nominal Rivet Diameter	(L) Nominal Rivet Body Length	(F) Nominal Blind Side Protrusion	Grip Range	Rivet Part Number	Hole Size	Rivet Dimensions				Shear Strength	Tensile Strength
						(D) Body Diameter	(H) Flange Thickness	(E) Flange Diameter	(W) Nominal Mandrel Diameter		
In. (mm)	In. (mm)	In. (mm)	In. (mm)		In. (mm)	In. (mm)	In. (mm)	In. (mm)	In. (mm)	Lbs. (N)	Lbs. (N)
5056 Aluminum Body/Steel Mandrel – Large Flange – Finish: Plain/Protective Coating											
1/8 (3.2)	.250 (6.4)	.370 (9.4)	.063-.125 (1.6-3.2)	AD 42 BS LF	.129-.133 (3.28-3.38)	.122-.128 (3.10-3.25)	.065-.073 (1.65-1.85)	.360-.390 (9.14-9.91)	.076 (1.93)	210 (934)	325 (1445)
	.313 (8.0)	.433 (11.0)	.126-.187 (3.2-4.8)	AD 43 BS LF							
	.375 (9.5)	.495 (12.6)	.188-.250 (4.8-6.4)	AD 44 BS LF							
	.500 (12.7)	.620 (15.7)	.313-.375 (7.9-9.5)	AD 46 BS LF							
5/32 (4.0)	.400 (10.2)	.540 (13.7)	.188-.250 (4.8-6.4)	AD 54 BS LF	.160-.164 (4.06-4.17)	.153-.159 (3.89-4.04)	.042-.056 (1.07-1.42)	.448-.488 (11.38-12.40)	.095 (2.41)	340 (1512)	490 (2179)
3/16 (4.8)	.300 (7.6)	.460 (11.7)	.063-.125 (1.6-3.2)	AD 62 BS LF	.192-.196 (4.88-4.98)	.183-.191 (4.65-4.85)	.067-.083 (1.70-2.11)	.600-.650 (15.24-16.51)	.114 (2.90)	445 (1979)	720 (3202)
	.425 (10.8)	.585 (14.9)	.126-.250 (3.2-6.4)	AD 64 BS LF							
	.550 (14.0)	.710 (18.0)	.251-.375 (6.4-9.5)	AD 66 BS LF							
	.675 (17.2)	.835 (21.2)	.376-.500 (9.5-12.7)	AD 68 BS LF							
	.800 (20.3)	.960 (24.4)	.501-.625 (12.7-15.9)	AD 610 BS LF							
	.925 (23.5)	1.085 (27.6)	.626-.750 (15.9-19.1)	AD 612 BS LF							
	1.05 (26.7)	1.210 (30.7)	.751-.875 (19.1-22.2)	AD 614 BS LF							
	1.175 (29.9)	1.335 (33.9)	.876-1.00 (22.2-25.4)	AD 616 BS LF							

**POP® Brand Rivets
In
Lighting Applications**



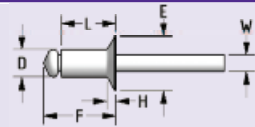
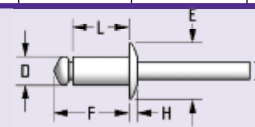

POP® Open End Rivets

Nominal Rivet Diameter	(L) Nominal Rivet Body Length	(F) Nominal Blind Side Protrusion	Grip Range	Rivet Part Number	Hole Size					Shear Strength	Tensile Strength
						(D) Body Diameter	(H) Flange Thickness	(E) Flange Diameter	(W) Nominal Mandrel Diameter		
In. (mm)	In. (mm)	In. (mm)	In. (mm)		In. (mm)	In. (mm)	In. (mm)	In. (mm)	In. (mm)	Lbs. (N)	Lbs. (N)
5056 Aluminum Body/Steel Mandrel – 120° Countersunk – Finish: Plain/Protective Coating											
1/8 <i>(3.2)</i>	.250 <i>(6.4)</i>	.370 <i>(9.4)</i>	.063-.125 <i>(1.6-3.2)</i>	AK 42 BS	.129-.133 <i>(3.28-3.38)</i>	.122-.128 <i>(3.10-3.25)</i>	.051 Max <i>(1.30)</i>	.207-.233 <i>(5.26-5.92)</i>	.076 <i>(1.93)</i>	210 <i>(934)</i>	325 <i>(1445)</i>
	.313 <i>(8.0)</i>	.433 <i>(11.0)</i>	.126-.187 <i>(3.2-4.8)</i>	AK 43 BS							
	.375 <i>(9.5)</i>	.495 <i>(12.6)</i>	.188-.250 <i>(4.8-6.4)</i>	AK 44 BS							
	.438 <i>(11.1)</i>	.558 <i>(14.2)</i>	.251-.312 <i>(6.4-7.9)</i>	AK 45 BS							
	.500 <i>(12.7)</i>	.620 <i>(15.7)</i>	.313-.375 <i>(7.9-9.5)</i>	AK 46 BS							
	.625 <i>(15.9)</i>	.745 <i>(18.9)</i>	.376-.500 <i>(9.5-12.7)</i>	AK 48 BS							
5/32 <i>(4.0)</i>	.275 <i>(7.0)</i>	.415 <i>(10.5)</i>	.063-.125 <i>(1.6-3.2)</i>	AK 52 BS	.160-.164 <i>(4.06-4.17)</i>	.153-.159 <i>(3.89-4.04)</i>	.063 Max <i>(1.60)</i>	.266-.296 <i>(6.76-7.52)</i>	.095 <i>(2.41)</i>	340 <i>(1512)</i>	490 <i>(2179)</i>
	.400 <i>(10.2)</i>	.540 <i>(13.7)</i>	.126-.250 <i>(3.2-6.4)</i>	AK 54 BS							
	.525 <i>(13.3)</i>	.665 <i>(16.9)</i>	.251-.375 <i>(6.4-9.5)</i>	AK 56 BS							
3/16 <i>(4.8)</i>	.425 <i>(10.8)</i>	.585 <i>(14.9)</i>	.126-.250 <i>(3.2-6.4)</i>	AK 64 BS	.192-.196 <i>(4.88-4.98)</i>	.183-.191 <i>(4.65-4.85)</i>	.071 Max <i>(1.80)</i>	.333-.363 <i>(8.46-9.22)</i>	.114 <i>(2.90)</i>	445 <i>(1979)</i>	720 <i>(3202)</i>
	.550 <i>(14.0)</i>	.710 <i>(18.0)</i>	.251-.375 <i>(6.4-9.5)</i>	AK 66 BS							
Nominal Rivet Diameter	(L) Nominal Rivet Body Length	(F) Nominal Blind Side Protrusion	Grip Range	Rivet Part Number	Hole Size					Shear Strength	Tensile Strength
						(D) Body Diameter	(H) Flange Thickness	(E) Flange Diameter	(W) Nominal Mandrel Diameter		
C1006-C1010 Steel Body/Steel Mandrel – Domed Head – Finish: Zinc/Protective Coating											
3/32 <i>(2.4)</i>	.225 <i>(5.7)</i>	.325 <i>(8.3)</i>	.032-.125 <i>(.8-3.2)</i>	SD 32 BS	.097-.100 <i>(2.46-2.54)</i>	.092-.096 <i>(2.34-2.44)</i>	.024-.032 <i>(0.61-0.81)</i>	.178-.198 <i>(4.52-5.03)</i>	.057 <i>(1.45)</i>	150 <i>(667)</i>	205 <i>(912)</i>
	.350 <i>(8.9)</i>	.450 <i>(11.4)</i>	.126-.250 <i>(3.2-6.4)</i>	SD 34 BS							

POP® Brand Rivets In Furniture Applications





Nominal Rivet Diameter	(L) Nominal Rivet Body Length	(F) Nominal Blind Side Protrusion	Grip Range	Rivet Part Number	Hole Size	Dimensions				Shear Strength	Tensile Strength
						(D) Body Diameter	(H) Flange Thickness	(E) Flange Diameter	(W) Nominal Mandrel Diameter		
In. (mm)	In. (mm)	In. (mm)	In. (mm)		In. (mm)	In. (mm)	In. (mm)	In. (mm)	In. (mm)	Lbs. (N)	Lbs. (N)
C1006-C1010 Steel Body/Steel Mandrel – Domed Head – Finish: Zinc/Protective Coating											
1/8 (3.2)	.188 (4.8)	.308 (7.8)	.032-.062 (.8-1.6)	SD 41 BS	.129-.133 (3.28-3.38)	.122-.128 (3.10-3.25)	.032-.040 (0.81-1.02)	.238-.262 (6.05-6.66)	.076 (1.93)	295 (1312)	425 (1891)
	.250 (6.4)	.370 (9.4)	.063-.125 (1.6-3.2)	SD 42 BS							
	.313 (8.0)	.433 (11.0)	.126-.187 (3.2-4.8)	SD 43 BS							
	.375 (9.5)	.495 (12.6)	.188-.250 (4.8-6.4)	SD 44 BS							
	.438 (11.1)	.558 (14.2)	.251-.312 (6.4-7.9)	SD 45 BS							
	.500 (12.7)	.620 (15.8)	.313-.375 (7.9-9.5)	SD 46 BS							
	.625 (15.9)	.745 (18.9)	.376-.500 (9.5-12.7)	SD 48 BS							
5/32 (4.0)	.275 (7.0)	.415 (10.5)	.063-.125 (1.6-3.2)	SD 52 BS	.160-.164 (4.06-4.17)	.153-.159 (3.89-4.04)	.039-.047 (0.99-1.19)	.296-.328 (7.52-8.33)	.095 (2.41)	410 (1824)	570 (2535)
	.338 (8.6)	.478 (12.1)	.126-.187 (3.2-4.8)	SD 53 BS							
	.400 (10.2)	.540 (13.7)	.188-.250 (4.8-6.4)	SD 54 BS							
	.525 (13.3)	.665 (16.9)	.251-.375 (6.4-9.5)	SD 56 BS							
	.650 (16.5)	.790 (20.1)	.376-.500 (9.5-12.7)	SD 58 BS							
3/16 (4.8)	.300 (7.6)	.460 (11.7)	.063-.125 (1.6-3.2)	SD 62 BS	.192-.196 (4.88-4.98)	.183-.191 (4.65-4.85)	.047-.055 (1.19-1.40)	.357-.393 (9.07-9.98)	.114 (2.90)	590 (2624)	815 (3625)
	.425 (10.8)	.585 (14.9)	.126-.250 (3.2-6.4)	SD 64 BS							
	.550 (14.0)	.710 (18.0)	.251-.375 (6.4-9.5)	SD 66 BS							
	.675 (17.2)	.835 (21.2)	.376-.500 (9.5-12.7)	SD 68 BS							
	.800 (20.3)	.960 (24.4)	.501-.625 (12.7-15.9)	SD 610 BS							
	.925 (23.5)	1.085 (27.6)	.626-.750 (15.9-19.1)	SD 612 BS							
	1.05 (26.7)	1.210 (30.7)	.751-.875 (19.1-22.2)	SD 614 BS							
	1.175 (29.9)	1.335 (33.9)	.876-1.00 (22.2-25.4)	SD 616 BS							



POP® Open End Rivets

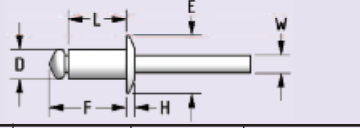



Nominal Rivet Diameter	(L) Nominal Rivet Body Length	(F) Nominal Blind Side Protrusion	Grip Range	Rivet Part Number	Hole Size					Shear Strength	Tensile Strength
						(D) Body Diameter	(H) Flange Thickness	(E) Flange Diameter	(W) Nominal Mandrel Diameter		
In. (mm)	In. (mm)	In. (mm)	In. (mm)		In. (mm)	In. (mm)	In. (mm)	In. (mm)	In. (mm)	Lbs. (N)	Lbs. (N)
C1006-C1010 Steel Body/Steel Mandrel – Domed Head – Finish: Zinc/Protective Coating											
1/4 (6.4)	.475 (12.1)	.710 (18.0)	.063-.250 (1.6-6.4)	SD 84 BS	.257-.261 (6.53-6.63)	.249-.255 (6.32-6.48)	.065-.073 (1.65-1.85)	.475-.525 (12.06-13.34)	.151 (3.84)	1245 (5538)	1505 (6694)
	.600 (15.2)	.835 (21.2)	.251-.375 (6.4-9.5)	SD 86 BS							
	.725 (18.4)	.960 (24.4)	.376-.500 (9.5-12.7)	SD 88 BS							
	.850 (21.6)	1.085 (27.6)	.501-.625 (12.8-15.9)	SD 810 BS							
	.975 (24.8)	1.210 (30.7)	.626-.750 (15.9-19.1)	SD 812 BS							
	1.10 (27.9)	1.335 (33.9)	.751-.875 (19.1-22.2)	SD 814 BS							
	1.225 (31.1)	1.460 (37.1)	.876-1.00 (22.2-25.4)	SD 816 BS							
C1006-C1010 Steel Body/Steel Mandrel – Large Flange – Finish: Zinc/Protective Coating											
1/8 (3.2)	.250 (6.5)	.370 (9.4)	.063-.125 (1.6-3.2)	SD 42 BS LF	.129-.133 (3.28-3.38)	.122-.128 (3.10-3.25)	.034-.046 (0.86-1.17)	.360-.390 (9.14-9.91)	.076 (1.93)	295 (1312)	425 (1891)
	.313 (8.0)	.433 (11.0)	.126-.187 (3.2-4.8)	SD 43 BS LF							
	.375 (9.5)	.495 (12.6)	.188-.250 (4.8-6.4)	SD 44 BS LF							
	.500 (12.7)	.620 (15.7)	.251-.375 (6.4-9.5)	SD 46 BS LF							
5/32 (4.0)	.338 (8.6)	.478 (12.1)	.126-.187 (3.2-4.8)	SD 53 BS LF	.160-.164 (4.06-4.17)	.153-.159 (3.89-4.04)	.042-.056 (1.07-1.42)	.448-.488 (11.38-12.40)	.095 (2.41)	410 (1824)	570 (2535)
	.400 (10.2)	.540 (13.7)	.188-.250 (4.8-6.4)	SD 54 BS LF							
	.525 (13.3)	.665 (16.9)	.251-.375 (6.4-9.5)	SD 56 BS LF							



POP® Brand Rivets In Building & Construction Applications

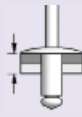

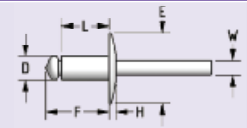

Nominal Rivet Diameter	(L) Nominal Rivet Body Length	(F) Nominal Blind Side Protrusion	 Grip Range	Rivet Part Number	 Hole Size					 Shear Strength	 Tensile Strength
						(D) Body Diameter	(H) Flange Thickness	(E) Flange Diameter	(W) Nominal Mandrel Diameter		
In. (mm)	In. (mm)	In. (mm)	In. (mm)		In. (mm)	In. (mm)	In. (mm)	In. (mm)	In. (mm)	Lbs. (N)	Lbs. (N)
C1006-C1010 Steel Body/Steel Mandrel – Large Flange – Finish: Zinc/Protective Coating											
3/16 (4.8)	.300 (7.6)	.460 (11.7)	.063-.125 (1.6-3.2)	SD 62 BS LF	.192-.196 (4.88-4.98)	.183-.191 (4.65-4.85)	.067-.083 (1.70-2.11)	.600-.650 (15.24-16.51)	.114 (2.90)	590 (2624)	815 (3625)
	.425 (10.8)	.585 (14.9)	.126-.250 (3.2-6.4)	SD 64 BS LF							
	.550 (14.0)	.710 (18.0)	.251-.375 (6.4-9.5)	SD 66 BS LF							
	.675 (17.2)	.835 (21.2)	.376-.500 (9.5-12.7)	SD 68 BS LF							
	.800 (20.3)	.960 (24.4)	.501-.625 (12.8-15.9)	SD 610 BS LF							
	.925 (23.5)	1.085 (27.6)	.626-.750 (15.9-19.1)	SD 612 BS LF							
1.4 (6.4)	.600 (15.2)	.835 (21.2)	.251-.375 (6.4-9.5)	SD 86 BS LF	.257-.261 (6.53-6.63)	.249-.255 (6.32-6.48)	.098-.107 (2.49-2.72)	.720-.780 (18.29-19.81)	.151 (3.84)	1245 (5538)	1505 (6694)
	.850 (21.6)	1.085 (27.6)	.501-.625 (12.7-15.8)	SD 810 BS LF							
	1.100 (27.9)	1.335 (33.9)	.751-.875 (19.1-22.2)	SD 814 BS LF							
C1006-C1010 Steel Body/Steel Mandrel – 120° Countersunk – Finish: Zinc/Protective Coating											
3/32 (2.4)	.225 (5.8)	.325 (8.3)	.063-.125 (1.6-3.2)	SK 32 BS	.097-.100 (2.46-2.54)	.092-.096 (2.34-2.44)	.039 Max (0.99)	.161-.187 (4.09-4.75)	.057 (1.45)	150 (667)	205 (912)
1/8 (3.2)	.250 (6.4)	.370 (9.4)	.063-.125 (1.6-3.2)	SK 42 BS	.129-.133 (3.28-3.38)	.122-.128 (3.10-3.25)	.051 Max (1.30)	.207-.233 (5.26-5.92)	.076 (1.93)	295 (1312)	425 (1891)
	.313 (8.0)	.433 (11.0)	.126-.187 (3.2-4.8)	SK 43 BS							
	.375 (9.5)	.495 (12.6)	.188-.250 (4.8-6.4)	SK 44 BS							
	.500 (12.7)	.620 (15.7)	.313-.375 (7.9-9.5)	SK 46 BS							
5/32 (4.0)	.650 (16.5)	.790 (20.1)	.376-.500 (9.6-12.7)	SK 58 BS	.160-.164 (4.06-4.17)	.153-.159 (3.89-4.04)	.063 Max (1.60)	.266-.296 (6.75-7.52)	.095 (2.41)	410 (1824)	570 (2535)
3/16 (4.8)	.425 (10.8)	.585 (14.9)	.126-.250 (3.2-6.4)	SK 64 BS	.192-.196 (4.88-4.98)	.183-.191 (4.65-4.85)	.071 Max (1.80)	.333-.363 (8.46-9.22)	.114 (2.90)	590 (2624)	815 (3625)

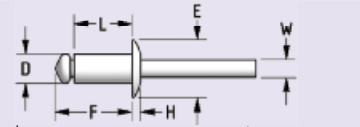

POP® Open End Rivets

Nominal Rivet Diameter	(L) Nominal Rivet Body Length	(F) Nominal Blind Side Protrusion	Grip Range	Rivet Part Number	Hole Size					Shear Strength	Tensile Strength
						(D) Body Diameter	(H) Flange Thickness	(E) Flange Diameter	(W) Nominal Mandrel Diameter		
In. (mm)	In. (mm)	In. (mm)	In. (mm)		In. (mm)	In. (mm)	In. (mm)	In. (mm)	In. (mm)	Lbs. (N)	Lbs. (N)
300 Series Stainless Steel Body/Stainless Steel Mandrel – Domed Head – Finish: Plain/Plain											
1/8 (3.2)	.188 (4.8)	.308 (7.8)	.032-.062 (.8-1.6)	SSD 41 SSBS	.129-.133 (3.28-3.38)	.122-.128 (3.10-3.25)	.032-.040 (0.81-1.02)	.238-.262 (6.05-6.66)	.076 (1.93)	550 (2446)	700 (3114)
	.250 (6.4)	.370 (9.4)	.063-.125 (1.6-3.2)	SSD 42 SSBS							
	.313 (8.0)	.433 (11.0)	.126-.187 (3.2-4.8)	SSD 43 SSBS							
	.375 (9.5)	.495 (12.6)	.188-.250 (4.8-6.4)	SSD 44 SSBS							
	.438 (11.1)	.558 (14.2)	.251-.312 (6.4-7.9)	SSD 45 SSBS							
	.500 (12.7)	.620 (15.8)	.313-.375 (7.9-9.5)	SSD 46 SSBS							
	.625 (15.9)	.745 (18.9)	.376-.500 (9.5-12.7)	SSD 48 SSBS							
5/32 (4.0)	.275 (7.0)	.415 (10.5)	.063-.125 (1.6-3.2)	SSD 52 SSBS	.160-.164 (4.06-4.17)	.153-.159 (3.89-4.04)	.039-.047 (0.99-1.19)	.296-.328 (7.52-8.33)	.095 (2.41)	900 (4003)	1130 (5027)
	.338 (9.9)	.478 (12.1)	.126-.187 (3.2-4.8)	SSD 53 SSBS							
	.400 (10.2)	.540 (13.7)	.188-.250 (4.8-6.4)	SSD 54 SSBS							
	.525 (13.3)	.665 (16.9)	.251-.375 (6.4-9.5)	SSD 56 SSBS							
3/16 (4.8)	.300 (7.6)	.460 (11.7)	.063-.125 (1.6-3.2)	SSD 62 SSBS	.192-.196 (4.88-4.98)	.183-.191 (4.65-4.85)	.047-.055 (1.19-1.40)	.357-.393 (9.07-9.98)	.114 (2.90)	1000 (4448)	1375 (6116)
	.425 (10.8)	.585 (14.9)	.126-.250 (3.2-6.4)	SSD 64 SSBS							
	.550 (14.0)	.710 (18.0)	.251-.375 (6.4-9.5)	SSD 66 SSBS							
	.675 (17.2)	.835 (21.2)	.376-.500 (9.5-12.7)	SSD 68 SSBS							
	.800 (20.3)	.960 (24.4)	.501-.625 (12.8-15.9)	SSD 610 SSBS							
	1.17 (29.9)	1.335 (33.9)	.876-1.000 (22.3-25.4)	SSD 616 SSBS							

POP® Brand Rivets In Appliance Applications





Nominal Rivet Diameter	(L) Nominal Rivet Body Length	(F) Nominal Blind Side Protrusion	Grip Range	Rivet Part Number	Hole Size	Diagram				Shear Strength	Tensile Strength
						(D) Body Diameter	(H) Flange Thickness	(E) Flange Diameter	(W) Nominal Mandrel Diameter		
In. (mm)	In. (mm)	In. (mm)	In. (mm)		In. (mm)	In. (mm)	In. (mm)	In. (mm)	In. (mm)	Lbs. (N)	Lbs. (N)
300 Series Stainless Steel Body/Stainless Steel Mandrel – Large Flange – Finish: Plain/Plain											
1/8 (3.2)	.250 (6.4)	.370 (9.4)	.063-.125 (1.6-3.2)	SSD 42 SSBS LF	.129-.133 (3.28-3.38)	.122-.128 (3.10-3.25)	.034-.046 (0.86-1.17)	.360-.390 (9.14-9.91)	.076 (1.93)	550 (2446)	700 (3114)
	.313 (8.0)	.433 (11.0)	.126-.187 (3.2-4.8)	SSD 43 SSBS LF							
	.375 (9.5)	.495 (12.6)	.188-.250 (4.8-6.4)	SSD 44 SSBS LF							
5/32 (4.0)	.525 (13.3)	.665 (16.9)	.251-.375 (6.4-9.5)	SSD 56 SSBS LF	.160-.164 (4.06-4.17)	.153-.159 (3.89-4.04)	.042-.056 (1.07-1.42)	.448-.488 (11.38-12.40)	.095 (2.41)	900 (4003)	1130 (5026)
3/16 (4.8)	.425 (10.8)	.585 (14.9)	.126-.250 (3.2-6.4)	SSD 64 SSBS LF	.192-.196 (4.88-4.98)	.183-.191 (4.65-4.85)	.067-.083 (1.70-2.11)	.600-.650 (15.24-16.51)	.114 (2.90)	1000 (4448)	1375 (6116)
	.550 (14.0)	.710 (18.0)	.251-.375 (6.4-9.5)	SSD 66 SSBS LF							
	.675 (17.2)	.835 (21.2)	.376-.500 (9.5-12.7)	SSD 68 SSBS LF							
	.800 (20.3)	.960 (24.4)	.501-.625 (12.7-15.9)	SSD 610 SSBS LF							
	.925 (23.5)	1.085 (27.6)	.626-.750 (15.9-19.1)	SSD 612 SSBS LF							
300 Series Stainless Steel Body/Stainless Steel Mandrel – 120° Countersunk – Finish: Plain/Plain											
1/8 (3.2)	.275 (7.0)	.370 (9.4)	.063-.125 (1.6-3.2)	SSK 42 SSBS	.129-.133 (3.28-3.38)	.122-.128 (3.10-3.25)	.051 Max (1.30)	.207-.233 (5.26-5.92)	.076 (1.93)	550 (2446)	700 (3114)
	.313 (8.0)	.433 (11.0)	.126-.187 (3.2-4.8)	SSK 43 SSBS							
	.375 (9.5)	.495 (12.6)	.188-.250 (4.8-6.4)	SSK 44 SSBS							
3/16 (4.8)	.425 (10.8)	.585 (14.9)	.126-.250 (3.2-6.4)	SSK 64 SSBS	.192-.196 (4.88-4.98)	.183-.191 (4.65-4.85)	.071 Max (1.80)	.333-.363 (8.46-9.22)	.114 (2.90)	1000 (4448)	1375 (6119)
	.675 (17.2)	.835 (21.2)	.376-.500 (9.5-12.7)	SSK 68 SSBS							

**POP® Brand Rivets
In
Medical Equipment Applications**







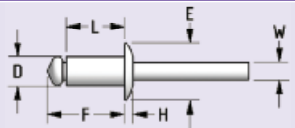







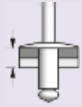

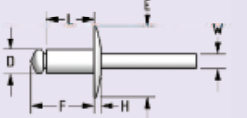
POP® Open End Rivets

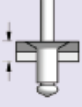
Nominal Rivet Diameter	(L) Nominal Rivet Body Length	(F) Nominal Blind Side Protrusion	Grip Range	Rivet Part Number	Hole Size					Shear Strength	Tensile Strength
						(D) Body Diameter	(H) Flange Thickness	(E) Flange Diameter	(W) Nominal Mandrel Diameter		
In. (mm)	In. (mm)	In. (mm)	In. (mm)		In. (mm)	In. (mm)	In. (mm)	In. (mm)	In. (mm)	Lbs. (N)	Lbs. (N)
300 Series Stainless Steel Body/Steel Mandrel – Domed Head – Finish: Plain/Protective Coating											
1/8 (3.2)	.188 (4.8)	.308 (7.8)	.032-.062 (.8-1.6)	SSD 41 BS	.129-.133 (3.28-3.38)	.122-.128 (3.10-3.25)	.032-.040 (0.81-1.02)	.238-.262 (6.05-6.66)	.076 (1.93)	550 (2448)	700 (3115)
	.250 (6.4)	.370 (9.4)	.063-.125 (1.6-3.2)	SSD 42 BS							
	.313 (8.0)	.433 (11.0)	.126-.187 (3.2-4.8)	SSD 43 BS							
	.375 (9.5)	.495 (12.6)	.188-.250 (4.8-6.4)	SSD 44 BS							
	.438 (11.1)	.558 (14.2)	.251-.312 (6.4-7.9)	SSD 45 BS							
	.500 (12.7)	.620 (15.8)	.313-.375 (7.9-9.5)	SSD 46 BS							
	.625 (15.9)	.745 (18.9)	.376-.500 (9.5-12.7)	SSD 48 BS							
5/32 (4.0)	.275 (7.0)	.415 (10.5)	.063-.125 (1.6-3.2)	SSD 52 BS	.160-.164 (4.06-4.17)	.153-.159 (3.89-4.04)	.039-.047 (0.99-1.19)	.296-.328 (7.52-8.33)	.095 (2.41)	900 (4005)	1130 (5029)
	.400 (10.2)	.540 (13.7)	.188-.250 (4.8-6.4)	SSD 54 BS							
	.525 (13.3)	.665 (16.9)	.251-.375 (6.4-9.5)	SSD 56 BS							
3/16 (4.8)	.300 (7.6)	.460 (11.7)	.063-.125 (1.6-3.2)	SSD 62 BS	.192-.196 (4.88-4.98)	.183-.191 (4.65-4.85)	.047-.055 (1.19-1.40)	.357-.393 (9.07-9.98)	.114 (2.90)	1000 (4450)	1375 (6119)
	.425 (10.8)	.585 (14.9)	.126-.250 (3.2-6.4)	SSD 64 BS							
	.550 (14.0)	.710 (18.0)	.251-.375 (6.4-9.5)	SSD 66 BS							
	.675 (17.2)	.835 (21.2)	.376-.500 (9.5-12.7)	SSD 68 BS							
	.800 (20.3)	.960 (24.4)	.501-.625 (12.7-15.9)	SSD 610 BS							

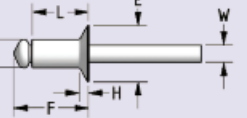
POP® Brand Rivets In Commercial Appliance Applications

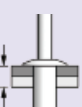

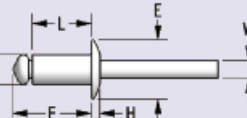

Nominal Rivet Diameter	(L) Nominal Rivet Body Length	(F) Nominal Blind Side Protrusion	 Grip Range	Rivet Part Number	 Hole Size					 Shear Strength	 Tensile Strength
						(D) Body Diameter	(H) Flange Thickness	(E) Flange Diameter	(W) Nominal Mandrel Diameter		
In. (mm)	In. (mm)	In. (mm)	In. (mm)		In. (mm)	In. (mm)	In. (mm)	In. (mm)	In. (mm)	Lbs. (N)	Lbs. (N)
300 Series Stainless Steel Body/Steel Mandrel – Large Flange – Finish: Plain/Protective Coating											
1/8 (3.2)	.250 (6.4)	.370 (9.4)	.063-.125 (1.6-3.2)	SSD 42 BS LF	.129-.133 (3.28-3.38)	.122-.128 (3.10-3.25)	.034-.046 (0.86-1.17)	.360-.390 (9.14-9.91)	.076 (1.93)	550 (2448)	700 (3115)
	.313 (8.0)	.433 (11.0)	.126-.187 (3.2-4.8)	SSD 43 BS LF							
	.375 (9.5)	.495 (12.6)	.188-.250 (4.8-6.4)	SSD 44 BS LF							
3/16 (4.8)	.800 (20.3)	.960 (24.4)	.501-.625 (12.8-15.9)	SSD 610 BS LF	.192-.196 (4.88-4.98)	.183-.191 (4.65-4.85)	.067-.083 (1.70-2.11)	.600-.650 (15.24-16.51)	.114 (2.90)	1000 (4450)	1375 (6119)
Nominal Rivet Diameter	(L) Nominal Rivet Body Length	(F) Nominal Blind Side Protrusion	 Grip Range	Rivet Part Number	 Hole Size					 Shear Strength	 Tensile Strength
						(D) Body Diameter	(H) Flange Thickness	(E) Flange Diameter	(W) Nominal Mandrel Diameter		
300 Series Stainless Steel Body/Steel Mandrel – 120° Countersunk – Finish: Plain/Protective Coating											
1/8 (3.2)	.275 (7.0)	.370 (9.4)	.063-.125 (1.6-3.2)	SSK 42 BS	.129-.133 (3.28-3.38)	.122-.128 (3.10-3.25)	.030-.050 (0.76-1.27)	.207-.233 (5.26-5.92)	.076 (1.93)	550 (2448)	700 (3115)
3/16 (4.8)	.425 (10.8)	.585 (14.9)	.126-.250 (3.2-6.4)	SSK 64 BS	.192-.196 (4.88-4.98)	.183-.191 (4.65-4.85)	.045-.055 (1.14-1.40)	.333-.363 (8.46-9.22)	.114 (2.90)	1000 (4450)	1375 (6119)
Nominal Rivet Diameter	(L) Nominal Rivet Body Length	(F) Nominal Blind Side Protrusion	 Grip Range	Rivet Part Number	 Hole Size					 Shear Strength	 Tensile Strength
						(D) Body Diameter	(H) Flange Thickness	(E) Flange Diameter	(W) Nominal Mandrel Diameter		
110 Copper Body/Steel Mandrel – Domed Head – Finish: Plain/Protective Coating											
1/8 (3.2)	.250 (6.4)	.370 (9.4)	.063-.125 (1.6-3.2)	CD 42 BS	.129-.133 (3.28-3.38)	.122-.128 (3.10-3.25)	.032-.040 (0.81-1.02)	.238-.262 (6.05-6.66)	.076 (1.93)	215 (957)	300 (1335)
	.375 (9.5)	.495 (12.6)	.188-.250 (4.8-6.4)	CD 44 BS							
	.500 (12.7)	.620 (15.8)	.313-.375 (7.9-9.5)	CD 46 BS							

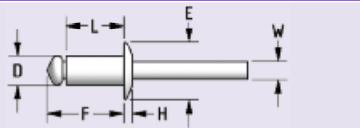

POP® Open End Rivets

Nominal Rivet Diameter	(L) Nominal Rivet Body Length	(F) Nominal Blind Side Protrusion	Grip Range	Rivet Part Number	Hole Size					Shear Strength	Tensile Strength
						(D) Body Diameter	(H) Flange Thickness	(E) Flange Diameter	(W) Nominal Mandrel Diameter		
In. (mm)	In. (mm)	In. (mm)	In. (mm)		In. (mm)	In. (mm)	In. (mm)	In. (mm)	In. (mm)	Lbs. (N)	Lbs. (N)
Nickel Copper Alloy (Monel) Body/Steel Mandrel – Domed Head – Finish: Zinc/Zinc											
7/64 (2.8)	.195 (5.0)	.295 (7.5)	.020-.070 (.51-1.8)	MD 319 BS	.113-.117 (2.87-2.97)	.107-.113 (2.72-2.87)	.012-.028 (0.31-0.71)	.179-.205 (4.55-5.21)	.072 (1.83)	258 (1150)	292 (1300)
	.217 (5.5)	.317 (8.1)	.070-.090 (1.8-2.3)	MD 321 BS							
1/8 (3.2)	.242 (6.2)	.362 (9.2)	.071-.121 (3.1-4.3)	TLPD 424 BS	.130-.134 (3.3-3.4)	.124-.129 (3.16-3.28)	.028 Max (0.72)	.243 Max (6.17)	.076 (1.93)	337 (1500)	427 (1900)
	.293 (7.5)	.413 (10.5)	.121-.168 (3.1-4.3)	TLPD 429 BS							
	.352 (9.0)	.472 (12.0)	.168-.227 (4.3-5.8)	TLPD 435 BS							
	.402 (10.3)	.522 (13.3)	.227-.277 (5.8-7.1)	TLPD 440 BS							
5/32 (4.0)	.305 (7.8)	.445 (11.3)	.098-.160 (2.5-4.1)	TLPD 530 BS	.161-.165 (4.1-4.2)	.153-.161 (3.90-4.08)	.031 Max (0.80)	.272 Max (6.9)	.090 (2.29)	495 (2200)	674 (5000)
	.375 (9.5)	.511 (13.0)	.160-.228 (4.1-5.8)	TLPD 537 BS							
	.405 (10.3)	.542 (13.8)	.228-.260 (5.8-6.6)	TLPD 540 BS							
	.453 (11.5)	.590 (15.0)	.260-.311 (6.6-7.9)	TLPD 545 BS							
3/16 (4.8)	.301 (7.7)	.461 (11.7)	.090-.148 (2.3-3.8)	MD 630 BS	.192-.196 (4.88-4.98)	.185-.191 (4.70-4.85)	.025-.055 (0.64-1.40)	.300-.340 (7.62-8.64)	.114 (2.90)	742 (3300)	844 (3750)
	.363 (9.3)	.523 (13.3)	.148-.199 (3.8-5.1)	MD 636 BS							
	.391 (10.0)	.551 (14.0)	.199-.227 (5.1-5.8)	MD 639 BS							
	.500 (12.7)	.660 (16.8)	.227-.336 (5.8-8.6)	MD 650 BS							
	.645 (16.5)	.805 (20.5)	.336-.488 (8.6-12.5)	MD 665 BS							
	.742 (19.0)	.902 (22.9)	.488-.586 (12.5-15.0)	MD 675 BS							
1/4 (6.4)	.500 (12.7)	.735 (18.7)	0-.297 (0-7.6)	MD 850 BS	.257-.261 (6.53-6.63)	.251-.257 (6.38-6.53)	.038-.068 (0.97-1.73)	.402-.452 (10.21-11.48)	.152 (3.86)	1215 (5400)	1519 (6750)
	.703 (18.0)	.938 (23.8)	.297-.496 (7.6-12.7)	MD 870 BS							



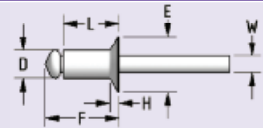



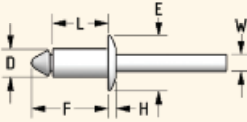



Nominal Rivet Diameter	(L) Nominal Rivet Body Length	(F) Nominal Blind Side Protrusion	Grip Range	Rivet Part Number	Hole Size					Shear Strength	Tensile Strength
						(D) Body Diameter	(H) Flange Thickness	(E) Flange Diameter	(W) Nominal Mandrel Diameter		
In. (mm)	In. (mm)	In. (mm)	In. (mm)		In. (mm)	In. (mm)	In. (mm)	In. (mm)	In. (mm)	Lbs. (N)	Lbs. (N)
Nickel Copper Alloy (Monel) Body/Steel Mandrel – 120° Countersunk – Finish: Zinc/Zinc											
7/64 (2.8)	.215 (5.5)	.315 (8.0)	0-.090 (0-2.3)	MK 319 BS	.113-.117 (2.87-2.97)	.107-.113 (2.72-2.87)	.018-.038 (0.46-0.97)	.179-.205 (4.55-5.21)	.072 (1.83)	258 (1150)	292 (1300)
	.234 (6.0)	.334 (8.5)	.090-.109 (2.3-2.8)	MK 321 BS							
1/8 (3.2)	.227 (5.8)	.347 (8.8)	0-.098 (0-2.5)	TLPK 419 BS	.130-.134 (3.3-3.4)	.124-.129 (3.15-3.28)	.039 Max (1.0)	.244 Max (6.2)	.076 (1.93)	337 (1500)	427 (1900)
	.273 (7.0)	.393 (10.0)	.098-.148 (2.5-3.8)	TLPK 424 BS							
	.332 (8.5)	.452 (11.5)	.148-.199 (3.8-5.1)	TLPK 429 BS							
	.391 (10.0)	.511 (13.0)	.199-.259 (5.1-6.6)	TLPK 435 BS							
	.438 (11.2)	.558 (14.2)	.259-.309 (6.6-7.9)	TLPK 440 BS							
5/32 (4.0)	.281 (7.2)	.421 (10.7)	0-.129 (0-3.3)	TLPK 524 BS	.161-.165 (4.1-4.2)	.153-.161 (3.90-4.08)	.042 Max (1.07)	.270 Max (6.86)	.090 (2.29)	495 (2200)	674 (3000)
	.340 (8.7)	.480 (12.2)	.129-.188 (3.3-4.8)	TLPK 530 BS							
	.410 (10.5)	.550 (14.0)	.188-.258 (4.8-6.6)	TLPK 537 BS							
	.441 (11.3)	.581 (14.8)	.258-.289 (6.6-7.4)	TLPK 540 BS							
3/16 (4.8)	.290 (7.4)	.450 (11.4)	0-.120 (0-3.1)	MK 624 BS	.192-.196 (4.88-4.98)	.185-.191 (4.70-4.85)	.025-.055 (0.64-1.40)	.300-.340 (7.62-8.64)	.114 (2.90)	742 (3300)	844 (3750)
	.383 (9.0)	.543 (13.8)	0-.180 (0-4.6)	MK 630 BS							
	.410 (10.5)	.570 (14.5)	.180-.227 (4.6-5.8)	MK 636 BS							
	.430 (11.0)	.590 (15.0)	.227-.259 (5.8-6.6)	MK 639 BS							
	.547 (14.0)	.707 (18.0)	.259-.367 (6.6-9.4)	MK 650 BS							
	.703 (18.0)	.863 (21.9)	.367-.516 (9.4-13.1)	MK 665 BS							
	.801 (20.5)	.961 (24.4)	.516-.617 (13.2-15.7)	MK 675 BS							

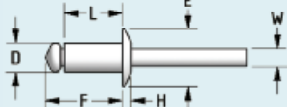

Nominal Rivet Diameter	(L) Nominal Rivet Body Length	(F) Nominal Blind Side Protrusion	Grip Range	Rivet Part Number	Hole Size					Shear Strength	Tensile Strength
						(D) Body Diameter	(H) Flange Thickness	(E) Flange Diameter	(W) Nominal Mandrel Diameter		
In. (mm)	In. (mm)	In. (mm)	In. (mm)		In. (mm)	In. (mm)	In. (mm)	In. (mm)	In. (mm)	Lbs. (N)	Lbs. (N)
5056 Aluminum Body/Steel Mandrel – Domed Head – Finish: Plain/Protective Coating											
1/8 (3.2)	.250 (6.4)	.415 (10.5)	.031-.094 (.8-2.4)	EAD 42 BS	.129-.133 (3.28-3.38)	.122-.128 (3.10-3.25)	.032-.040 (0.81-1.02)	.238-.262 (6.05-6.66)	.076 (1.93)	210 (935)	325 (1446)
	.313 (8.0)	.478 (12.1)	.095-.156 (2.4-4.0)	EAD 43 BS							
	.375 (9.5)	.540 (13.7)	.157-.218 (4.0-5.5)	EAD 44 BS							
5/32 (4.0)	.400 (10.2)	.565 (14.4)	.188-.218 (4.8-5.5)	EAD 54 BS	.160-.164 (4.06-4.17)	.153-.159 (3.89-4.04)	.039-.047 (0.99-1.19)	.296-.328 (7.52-8.33)	.095 (2.41)	340 (1513)	490 (2181)
5056 Aluminum Body/Steel Mandrel – Large Flange – Finish: Plain/Protective Coating											
1/8 (3.2)	.375 (9.5)	.540 (13.7)	.157-.218 (4.0-5.5)	EAD 44 BS LF	.129-.133 (3.28-3.38)	.122-.128 (3.12-3.28)	.057-.065 (1.45-1.65)	.360-.390 (9.14-9.91)	.076 (1.93)	210 (935)	325 (1446)
C1006-C1010 Steel Body/Steel Mandrel – Domed Head – Finish: Zinc/Protective Coating											
1/8 (3.2)	.250 (6.4)	.415 (10.5)	.031-.094 (.8-2.4)	ESD 42 BS	.129-.133 (3.28-3.38)	.122-.128 (3.10-3.25)	.032-.040 (0.81-1.02)	.238-.262 (6.05-6.66)	.076 (1.93)	295 (1313)	425 (1891)
	.313 (8.0)	.478 (12.1)	.095-.156 (2.4-4.0)	ESD 43 BS							
	.375 (9.5)	.540 (13.7)	.157-.218 (4.0-5.5)	ESD 44 BS							
3/16 (4.8)	.425 (10.8)	.660 (16.8)	.126-.218 (3.2-5.5)	ESD 64 BS	.192-.196 (4.88-4.98)	.183-.191 (4.65-4.85)	.047-.055 (1.19-1.40)	.359-.391 (9.12-9.93)	.114 (2.90)	590 (2626)	815 (3627)
	.550 (14.0)	.785 (19.9)	.251-.343 (6.4-8.7)	ESD 66 BS							
C1006-C1010 Steel Body/Steel Mandrel – Large Flange – Finish: Zinc/Protective Coating											
1/8 (3.2)	.375 (9.5)	.540 (13.7)	.157-.218 (4.0-5.6)	ESD 44 BS LF	.129-.133 (3.28-3.38)	.122-.128 (3.10-3.25)	.032-.040 (0.81-1.02)	.360-.390 (9.14-9.91)	.076 (1.93)	295 (1313)	425 (1891)

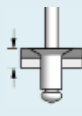
POP® Soft Set Rivets

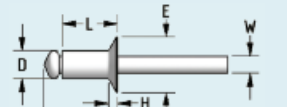

Nominal Rivet Diameter	(L) Nominal Rivet Body Length	(F) Nominal Blind Side Protrusion	 Grip Range	Rivet Part Number	 Hole Size					 Shear Strength	 Tensile Strength
						(D) Body Diameter	(H) Flange Thickness	(E) Flange Diameter	(W) Nominal Mandrel Diameter		
In. (mm)	In. (mm)	In. (mm)	In. (mm)		In. (mm)	In. (mm)	In. (mm)	In. (mm)	In. (mm)	Lbs. (N)	Lbs. (N)
1100 Aluminum Body/Aluminum Mandrel – Domed Head – Finish: Plain/Plain											
.118 (3.0)	.315 (8.1)	.492 (12.5)	.126-.189 (3.2-4.8)	PAD 30M3 ABS	.120-.124 (3.05-3.15)	.115-.121 (2.92-3.07)	.027-.043 (0.69-1.09)	.223-.246 (5.70-6.30)	.071 (1.80)	69 (310)	94 (420)
	.385 (9.8)	.559 (14.2)	.189-.252 (4.8-6.4)	PAD 30M4 ABS							
	.456 (11.6)	.630 (16.0)	.252-.315 (6.4-8.0)	PAD 30M5 ABS							
1/8 (3.2)	.188 (4.8)	.308 (7.8)	.032-.062 (1.1-1.6)	PAD 41 ABS	.129-.133 (3.28-3.38)	.122-.128 (3.10-3.25)	.032-.040 (0.81-1.02)	.238-.262 (6.05-6.66)	.076 (1.93)	65 (289)	85 (378)
	.250 (6.4)	.370 (9.4)	.063-.125 (1.6-3.2)	PAD 42 ABS							
	.313 (8.0)	.433 (11.0)	.126-.187 (3.2-4.8)	PAD 43 ABS							
	.375 (9.5)	.495 (12.6)	.188-.250 (4.8-6.4)	PAD 44 ABS							
	.438 (11.1)	.558 (14.2)	.251-.312 (6.4-7.9)	PAD 45 ABS							
	.500 (12.7)	.620 (15.8)	.313-.375 (7.9-9.5)	PAD 46 ABS							
5/32 (4.0)	.400 (10.2)	.540 (13.7)	.188-.250 (4.8-6.4)	PAD 54 ABS	.160-.164 (4.06-4.17)	.153-.159 (3.89-4.04)	.039-.047 (0.99-1.19)	.296-.328 (7.52-8.33)	.095 (2.41)	105 (467)	145 (645)
	.525 (13.3)	.665 (16.9)	.251-.375 (6.4-9.5)	PAD 56 ABS							
3/16 (4.8)	.425 (10.8)	.585 (14.9)	.126-.250 (3.2-6.4)	PAD 64 ABS	.192-.196 (4.88-4.98)	.183-.191 (4.65-4.85)	.047-.055 (1.19-1.40)	.357-.393 (9.07-9.98)	.114 (2.89)	145 (645)	205 (912)
	.550 (14.0)	.710 (18.0)	.251-.375 (6.4-9.5)	PAD 66 ABS							
	.675 (17.2)	.835 (21.2)	.376-.500 (9.5-12.7)	PAD 68 ABS							
Nominal Rivet Diameter	(L) Nominal Rivet Body Length	(F) Nominal Blind Side Protrusion	 Grip Range	Rivet Part Number	 Hole Size					 Shear Strength	 Tensile Strength
						(D) Body Diameter	(H) Flange Thickness	(E) Flange Diameter	(W) Nominal Mandrel Diameter		
1100 Aluminum Body/Aluminum Mandrel – Countersunk – Finish: Plain/Plain											
1/8 (3.2)	.250 (6.4)	.370 (9.4)	.063-.125 (1.6-3.2)	PAK 42 ABS	.129-.133 (3.28-3.38)	.122-.131 (3.10-3.33)	.051 Max (1.30)	.210-.230 (5.33-5.84)	.076 (1.93)	65 (289)	85 (378)
	.313 (8.0)	.433 (11.0)	.126-.187 (3.2-4.8)	PAK 43 ABS							
	.375 (9.5)	.495 (12.6)	.188-.250 (4.8-6.4)	PAK 44 ABS							



Nominal Rivet Diameter	(L) Nominal Rivet Body Length	(F) Nominal Blind Side Protrusion	Grip Range	Rivet Part Number	Hole Size	Dimensions				Shear Strength	Tensile Strength
						(D) Body Diameter	(H) Flange Thickness	(E) Flange Diameter	(W) Nominal Mandrel Diameter		
In. (mm)	In. (mm)	In. (mm)	In. (mm)		In. (mm)	In. (mm)	In. (mm)	In. (mm)	In. (mm)	Lbs. (N)	Lbs. (N)
5154 Aluminum Body/Steel Mandrel – Domed Head – Finish: Plain/Zinc											
.078 (2.0)	.161 (4.1)	.295 (7.5)	0-.063 (0-1.6)	TAPD 20M1 BS	.080-.084 (2.03-2.13)	.075-.081 (1.91-2.06)	.018-.029 (0.46-0.74)	.141-.156 (3.58-3.96)	.043 (1.10)	66 (295)	87 (390)
	.224 (5.7)	.358 (9.1)	.039-.126 (1.0-3.2)	TAPD 20M2 BS							
	.291 (7.4)	.425 (10.8)	.126-.189 (3.2-4.8)	TAPD 20M3 BS							
	.354 (9.0)	.488 (12.4)	.189-.252 (4.8-6.4)	TAPD 20M4 BS							
	.421 (10.7)	.555 (14.1)	.252-.315 (6.4-8.0)	TAPD 20M5 BS							

**POP[®] Brand Rivets
In
Electronics Applications**

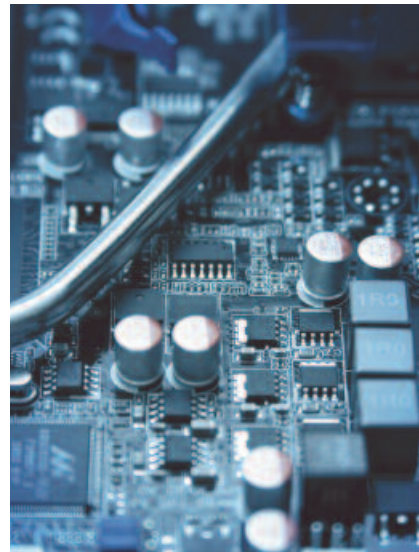

POP®

Multi-Grip™ Rivets



Nominal Rivet Diameter	(L) Nominal Rivet Body Length	(F) Nominal Blind Side Protrusion	Grip Range	Rivet Part Number	Hole Size	Dimensions				Shear Strength	Tensile Strength
						(D) Body Diameter	(H) Flange Thickness	(E) Flange Diameter	(W) Nominal Mandrel Diameter		
In. (mm)	In. (mm)	In. (mm)	In. (mm)		In. (mm)	In. (mm)	In. (mm)	In. (mm)	In. (mm)	Lbs. (N)	Lbs. (N)
1100 Aluminum Body/Aluminum Mandrel – Domed Head – Finish: Plain/Plain											
1/8 <i>(3.2)</i>	.313 <i>(7.9)</i>	.433 <i>(11.0)</i>	.039-.187 <i>(1.0-4.7)</i>	AD 41-43 ABS	.129-.142 <i>(3.28-3.61)</i>	.122-.128 <i>(3.10-3.25)</i>	.032-.040 <i>(0.81-1.02)</i>	.238-.262 <i>(6.05-6.66)</i>	.076 <i>(1.93)</i>	65 <i>(287)</i>	85 <i>(378)</i>
	.453 <i>(11.5)</i>	.573 <i>(14.6)</i>	.157-.312 <i>(3.9-7.9)</i>	AD 43-45 ABS							
	.594 <i>(15.0)</i>	.714 <i>(18.1)</i>	.251-.437 <i>(6.3-11.0)</i>	AD 45-47 ABS							
5/32 <i>(4.0)</i>	.400 <i>(10.2)</i>	.540 <i>(13.7)</i>	.047-.250 <i>(1.2-6.4)</i>	AD 52-54 ABS	.160-.173 <i>(4.06-4.39)</i>	.153-.159 <i>(3.89-4.04)</i>	.039-.047 <i>(0.99-1.19)</i>	.297-.327 <i>(7.54-8.31)</i>	.095 <i>(2.41)</i>	105 <i>(467)</i>	145 <i>(645)</i>
	.485 <i>(12.3)</i>	.625 <i>(15.9)</i>	.126-.312 <i>(3.2-7.9)</i>	AD 53-55 ABS							
3/16 <i>(4.8)</i>	.425 <i>(10.7)</i>	.585 <i>(14.9)</i>	.063-.250 <i>(1.6-6.3)</i>	AD 62-64 ABS	.192-.205 <i>(4.88-5.21)</i>	.183-.191 <i>(4.65-4.85)</i>	.047-.055 <i>(1.19-1.40)</i>	.360-.390 <i>(9.14-9.91)</i>	.114 <i>(2.90)</i>	145 <i>(644)</i>	205 <i>(911)</i>
	.605 <i>(15.3)</i>	.765 <i>(19.4)</i>	.188-.375 <i>(4.7-9.5)</i>	AD 63-66 ABS							
	.716 <i>(18.2)</i>	.876 <i>(22.3)</i>	.251-.500 <i>(6.3-12.7)</i>	AD 66-68 ABS							
	1.050 <i>(26.6)</i>	1.210 <i>(30.7)</i>	.438-.750 <i>(11.1-19.0)</i>	AD 68-612 ABS							
1100 Aluminum Body/Aluminum Mandrel – Large Flange – Finish: Plain/Plain											
1/8 <i>(3.2)</i>	.313 <i>(7.9)</i>	.433 <i>(11.0)</i>	.039-.187 <i>(1.0-4.7)</i>	AD 41-43 ABS LF	.129-.142 <i>(3.28-3.61)</i>	.122-.128 <i>(3.10-3.25)</i>	.036-.052 <i>(0.91-1.33)</i>	.360-.390 <i>(9.14-9.91)</i>	.076 <i>(1.93)</i>	65 <i>(287)</i>	85 <i>(378)</i>
5/32 <i>(4.0)</i>	.400 <i>(10.2)</i>	.540 <i>(13.7)</i>	.047-.250 <i>(1.2-6.4)</i>	AD 52-54 ABS LF	.160-.173 <i>(4.06-4.39)</i>	.153-.159 <i>(3.89-4.04)</i>	.055-.071 <i>(0.91-1.33)</i>	.448-.488 <i>(11.38-)</i>	.095 <i>(2.41)</i>	105 <i>(467)</i>	145 <i>(645)</i>
3/16 <i>(4.8)</i>	.425 <i>(10.7)</i>	.585 <i>(14.9)</i>	.063-.250 <i>(1.6-6.3)</i>	AD 62-64 ABS LF	.192-.205 <i>(4.88-5.21)</i>	.183-.191 <i>(4.65-4.85)</i>	.067-.083 <i>(1.70-2.11)</i>	.600-.650 <i>(15.24-16.51)</i>	.114 <i>(2.90)</i>	145 <i>(644)</i>	205 <i>(911)</i>
	.605 <i>(15.3)</i>	.765 <i>(19.4)</i>	.188-.375 <i>(4.7-9.5)</i>	AD 63-66 ABS LF							
	1.050 <i>(26.6)</i>	1.210 <i>(30.7)</i>	.438-.750 <i>(11.1-19.0)</i>	AD 68-612 ABS LF							

**POP® Brand Rivets
In
Recreational Vehicles
Applications**













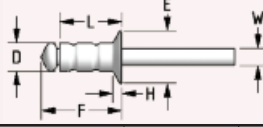

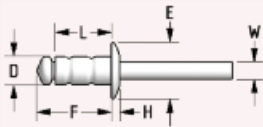

POP[®] Multi-Grip[™] Rivets

Nominal Rivet Diameter	(L) Nominal Rivet Body Length	(F) Nominal Blind Side Protrusion	Grip Range	Rivet Part Number	Hole Size	Dimensions				Shear Strength	Tensile Strength
						(D) Body Diameter	(H) Flange Thickness	(E) Flange Diameter	(W) Nominal Mandrel Diameter		
In. (mm)	In. (mm)	In. (mm)	In. (mm)		In. (mm)	In. (mm)	In. (mm)	In. (mm)	In. (mm)	Lbs. (N)	Lbs. (N)
5052 Aluminum Body/Steel Mandrel – Domed Head – Finish: Plain/Protective Coating											
1/8 (3.2)	.313 (8.0)	.433 (11.0)	.039-.187 (1.0-4.8)	AD 41-43 BS	.129-.142 (3.28-3.61)	.122-.128 (3.10-3.25)	.032-.040 (0.81-1.02)	.238-.262 (6.05-6.66)	.076 (1.93)	150 (667)	220 (978)
	.453 (11.5)	.573 (14.6)	.157-.312 (4.0-7.9)	AD 43-45 BS							
	.594 (15.1)	.714 (18.1)	.251-.437 (6.4-11.1)	AD 45-47 BS							
5/32 (4.0)	.400 (10.2)	.540 (13.7)	.047-.250 (1.2-6.4)	AD 52-54 BS	.160-.173 (4.06-4.39)	.153-.159 (3.89-4.04)	.039-.047 (0.99-1.19)	.297-.327 (7.54-8.31)	.095 (2.41)	250 (1112)	360 (1601)
	.485 (12.3)	.625 (15.9)	.126-.312 (3.2-7.9)	AD 53-55 BS							
	.715 (18.2)	.855 (21.7)	.251-.500 (6.4-12.7)	AD 56-58 BS							
3/16 (4.8)	.425 (10.8)	.585 (14.9)	.063-.250 (1.6-6.4)	AD 62-64 BS	.192-.205 (4.88-5.21)	.183-.191 (4.65-4.85)	.047-.055 (1.19-1.40)	.360-.390 (9.14-9.91)	.114 (2.90)	350 (1556)	505 (2246)
	.605 (15.4)	.765 (19.4)	.188-.375 (4.8-9.5)	AD 63-66 BS							
	.716 (18.2)	.876 (22.3)	.251-.500 (6.4-12.7)	AD 66-68 BS							
	1.05 (26.7)	1.21 (30.7)	.438-.750 (11.1-19.1)	AD 68-612 BS							
1/4 (6.4)	.600 (15.2)	.780 (19.8)	.080-.350 (2.0-8.9)	AD 82-86 BS	.257-.275 (6.53-6.99)	.249-.257 (6.32-6.53)	.065-.073 (1.65-1.85)	.475-.525 (12.06-13.34)	.151 (3.84)	460 (2046)	560 (2491)
5052 Aluminum Body/Steel Mandrel – Large Flange – Finish: Plain/Protective Coating											
1/8 (3.2)	.313 (8.0)	.433 (11.0)	.039-.187 (1.0-4.8)	AD 41-43 BS LF	.129-.142 (3.28-3.61)	.122-.128 (3.10-3.25)	.036-.052 (0.91-1.33)	.360-.390 (9.14-9.91)	.076 (1.93)	150 (667)	220 (978)
	.453 (11.5)	.573 (14.6)	.157-.312 (4.0-7.9)	AD 43-45 BS LF							
5/32 (4.0)	.400 (10.2)	.540 (13.7)	.047-.250 (1.2-6.4)	AD 52-54 BS LF	.160-.173 (4.06-4.39)	.153-.159 (3.89-4.04)	.055-.071 (1.40-1.80)	.448-.488 (11.38-12.40)	.095 (2.41)	250 (1112)	360 (1601)
	.485 (12.3)	.625 (15.9)	.126-.312 (3.2-7.9)	AD 53-55 BS LF							
3/16 (4.8)	.425 (10.8)	.585 (14.9)	.063-.250 (1.6-6.4)	AD 62-64 BS LF	.192-.205 (4.88-5.21)	.183-.191 (4.65-4.85)	.067-.083 (1.70-2.11)	.600-.650 (15.24-16.51)	.114 (2.90)	350 (1556)	505 (2246)
	.716 (18.2)	.876 (22.3)	.251-.500 (6.4-12.7)	AD 66-68 BS LF							
	1.050 (26.7)	1.210 (30.7)	.438-.750 (11.1-19.1)	AD 68-612 BS LF							

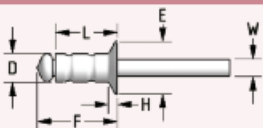

Nominal Rivet Diameter	(L) Nominal Rivet Body Length	(F) Nominal Blind Side Protrusion	 Grip Range	Rivet Part Number	 Hole Size					 Shear Strength	 Tensile Strength
						(D) Body Diameter	(H) Flange Thickness	(E) Flange Diameter	(W) Nominal Mandrel Diameter		
In. (mm)	In. (mm)	In. (mm)	In. (mm)		In. (mm)	In. (mm)	In. (mm)	In. (mm)	In. (mm)	Lbs. (N)	Lbs. (N)
5052 Aluminum Body/Steel Mandrel – 120° Countersunk – Finish: Plain/Protective Coating											
1/8 (3.2)	.375 (9.5)	.477 (12.1)	.039-.252 (1.0-6.4)	AK 41-44 BS	.129-.142 (3.28-3.61)	.122-.128 (3.10-3.25)	.051 Max (1.30)	.207-.233 (5.26-5.92)	.076 (1.93)	150 (667)	220 (978)
3/16 (4.8)	.565 (14.4)	.725 (18.4)	.126-.375 (3.2-9.6)	AK 64-66 BS	.192-.205 (4.88-5.21)	.183-.191 (4.65-4.85)	.071 Max (1.80)	.333-.363 (8.46-9.22)	.114 (2.90)	350 (1556)	505 (2246)
	.716 (18.2)	.876 (22.3)	.251-.500 (6.4-12.7)	AK 66-68 BS							
Nominal Rivet Diameter	(L) Nominal Rivet Body Length	(F) Nominal Blind Side Protrusion	 Grip Range	Rivet Part Number	 Hole Size					 Shear Strength	 Tensile Strength
5052 Aluminum Body/Stainless Steel Mandrel – Domed Head – Finish: Plain/Plain											
1/8 (3.2)	.313 (8.0)	.433 (11.0)	.039-.187 (1.0-4.8)	AD 41-43 SSBS	.129-.142 (3.28-3.61)	.122-.128 (3.10-3.25)	.032-.040 (0.81-1.02)	.238-.262 (6.05-6.66)	.076 (1.93)	150 (667)	220 (978)
5/32 (4.0)	.715 (18.2)	.855 (21.7)	.376-.500 (9.6-12.7)	AD 56-58 SSBS	.160-.173 (4.06-4.39)	.153-.159 (3.89-4.04)	.039-.047 (0.99-1.19)	.297-.327 (7.54-8.31)	.095 (2.41)	250 (1111)	360 (1600)
3/16 (4.8)	.425 (10.8)	.585 (14.9)	.063-.250 (1.6-6.4)	AD 62-64 SSBS	.192-.205 (4.88-5.21)	.183-.191 (4.68-4.89)	.047-.055 (1.19-1.40)	.360-.390 (9.14-9.91)	.114 (2.90)	350 (1556)	505 (2246)
	.605 (15.4)	.765 (19.4)	.188-.375 (4.8-9.5)	AD 63-66 SSBS							
5052 Aluminum Body/Stainless Steel Mandrel – Large Flange – Finish: Plain/Plain											
3/16 (4.8)	.425 (10.8)	.585 (14.9)	.063-.250 (1.6-6.4)	AD 62-64 SSBS LF	.192-.205 (4.88-5.21)	.183-.191 (4.65-4.85)	.067-.083 (1.70-2.11)	.600-.650 (15.24-16.51)	.114 (2.90)	350 (1556)	505 (2246)
	.716 (18.2)	.876 (22.3)	.126-.500 (3.2-12.7)	AD 64-68 SSBS LF							
	1.05 (26.7)	1.210 (30.7)	.438-.750 (11.1-19.1)	AD 68-612 SSBS LF							
Nominal Rivet Diameter	(L) Nominal Rivet Body Length	(F) Nominal Blind Side Protrusion	 Grip Range	Rivet Part Number	 Hole Size					 Shear Strength	 Tensile Strength
5052 Aluminum Body/Stainless Steel Mandrel – 120° Countersunk – Finish: Plain/Plain											
3/16 (4.8)	.565 (14.4)	.725 (18.4)	.126-.375 (3.2-9.6)	AK 64-66 SSBS	.192-.205 (4.88-5.21)	.183-.191 (4.65-4.85)	.067-.083 (1.70-2.11)	.335-.361 (8.51-9.12)	.114 (2.90)	350 (1556)	505 (2246)

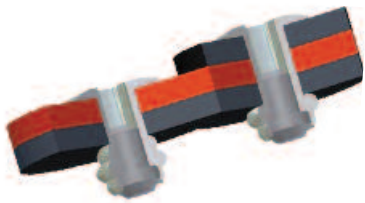

POP® Multi-Grip™ Rivets

Nominal Rivet Diameter	(L) Nominal Rivet Body Length	(F) Nominal Blind Side Protrusion	Grip Range	Rivet Part Number	Hole Size	Diagram				Shear Strength	Tensile Strength
						(D) Body Diameter	(H) Flange Thickness	(E) Flange Diameter	(W) Nominal Mandrel Diameter		
In. (mm)	In. (mm)	In. (mm)	In. (mm)		In. (mm)	In. (mm)	In. (mm)	In. (mm)	In. (mm)	Lbs. (N)	Lbs. (N)
C1002-C1010 Steel Body/Steel Mandrel – Domed Head – Finish: Zinc/Protective Coating											
1/8 (3.2)	.334 (8.5)	.512 (13.0)	.059-.197 (1.5-5.0)	MG21-03208-210	.130-.134 (3.30-3.40)	.120-.129 (3.05-3.28)	.031-.047 (0.79-1.19)	228-260 (5.79-6.60)	.076 (1.93)	270 (1200)	360 (1600)
	.492 (12.5)	.669 (17.0)	.157-.315 (4.0-8.0)	MG21-03212-210							
5/32 (4.0)	.413 (10.5)	.591 (15.0)	.059-.256 (1.5-6.5)	MG21-04010-210	.161-.165 (4.09-4.19)	.152-.160 (3.86-4.06)	.039-.055 (0.99-1.40)	.291-.327 (7.39-8.31)	.095 (2.41)	370 (1650)	540 (2400)
	.649 (16.5)	.827 (21.0)	.157-.472 (4.0-12.0)	MG21-04016-210							
3/16 (4.8)	.413 (10.5)	.610 (15.5)	.059-.236 (1.5-6.0)	MG21-04810-210	.193-.197 (4.90-5.00)	.183-.192 (4.65-4.85)	.047-.063 (1.19-1.60)	.354-.386 (8.99-9.80)	.114 (2.90)	607 (2700)	719 (3200)
	.649 (16.5)	.846 (21.5)	.157-.433 (4.0-11.0)	MG21-04816-210							
C1002-C1010 Steel Body/Steel Mandrel – Large Flange – Finish: Zinc/Protective Coating											
1/8 (3.2)	.334 (8.5)	.512 (13.0)	.059-.197 (1.5-5.0)	MG22-03208-210	.130-.134 (3.30-3.40)	.120-.129 (3.05-3.28)	.038-.058 (0.97-1.47)	.356-.395 (9.04-10.03)	.076 (1.93)	270 (1200)	360 (1600)
	.492 (12.5)	.669 (17.0)	.157-.315 (4.0-8.0)	MG22-03212-210							
5/32 (4.0)	.413 (10.5)	.591 (15.0)	.059-.256 (1.5-6.5)	MG22-04010-210	.161-.165 (4.09-4.19)	.152-.160 (3.86-4.06)	.054-.070 (1.37-1.78)	.430-.489 (10.92-12.42)	.095 (2.41)	370 (1650)	540 (2400)
	.649 (16.5)	.827 (21.0)	.157-.472 (4.0-12.0)	MG22-04016-210							
3/16 (4.8)	.413 (10.5)	.610 (15.5)	.059-.236 (1.5-6.0)	MG22-04810-210	.193-.197 (4.90-5.00)	.183-.192 (4.65-4.85)	.068-.084 (1.73-2.13)	.610-.650 (15.50-16.51)	.114 (2.90)	607 (2700)	719 (3200)
	.649 (16.5)	.846 (21.5)	.157-.433 (4.0-11.0)	MG22-04816-210							

POP® Brand Rivets In School Furniture and Equipment Applications

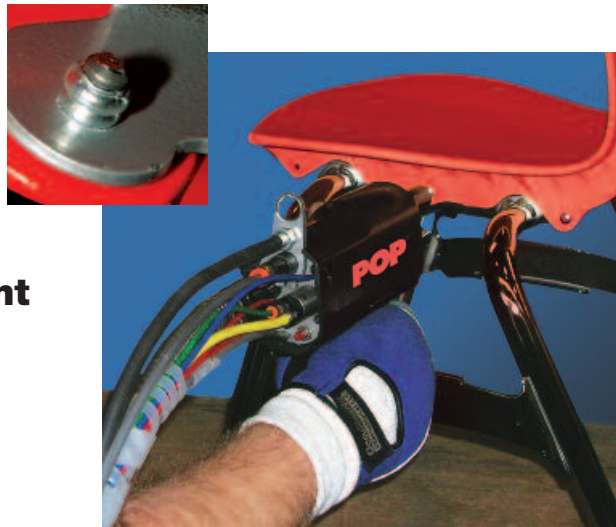



Load Spreading Rivets (LS/LSR)



Nominal Rivet Diameter	(L) Nominal Rivet Body Length	(F) Nominal Blind Side Protrusion	Grip Range	Rivet Part Number	Hole Size	Dimensions				Shear Strength	Tensile Strength
						(D) Body Diameter	(H) Flange Thickness	(E) Flange Diameter	(W) Nominal Mandrel Diameter		
In. (mm)	In. (mm)	In. (mm)	In. (mm)		In. (mm)	In. (mm)	In. (mm)	In. (mm)	In. (mm)	Lbs. (N)	Lbs. (N)
5154 Aluminum Body/Aluminum Mandrel – Domed Head – Finish: Plain/Plain											
1/8 (3.2)	.664 (16.9)	.755 (19.2)	0-.250 (0-6.4)	ACD 408 AS	.129-.133 (3.28-3.38)	.123-.128 (3.12-3.25)	.031-.039 (0.79-.99)	.236-.260 (5.99-6.60)	.072 (1.83)	124 (550)	202 (900)
5/32 (4.0)	.689 (17.5)	.780 (19.8)	0-.250 (0-6.4)	ACD 508 ASM	.165-.169 (4.19-4.29)	.154-.163 (3.91-4.14)	.045-.053 (1.14-1.35)	.297-.325 (7.54-8.26)	.090 (2.29)	202 (900)	292 (1300)
	.838 (21.3)	.929 (23.6)	.118-.375 (3.0-9.5)	ACD 512 ASM							
	.984 (25.0)	1.071 (27.2)	.197-.472 (5.0-12.0)	ACD 516 ASM							
3/16 (4.8)	.684 (17.4)	.815 (20.7)	0-.250 (0-6.4)	AD 64 ALS	.197-.205 (5.00-5.21)	.185-.196 (4.70-4.98)	.062 Max (1.57)	.363-.387 (9.22-9.83)	.104 (2.64)	225 (1000)	312 (1400)
	.775 (19.7)	.951 (23.2)	.118-.375 (3.0-9.5)	AD 66 ALS							
	.925 (23.5)	1.040 (26.4)	.197-.472 (5.0-12.0)	ACD 616 ASM							
5154 Aluminum Body/Aluminum Mandrel – Large Flange – Finish: Plain/Plain											
3/16 (4.8)	.684 (17.4)	.815 (20.7)	0-.250 (0-6.4)	AD 64 ALS LF	.197-.205 (5.00-5.21)	.185-.196 (4.70-4.98)	.081 Max (2.06)	.594-.630 (15.0-16.0)	.104 (2.64)	225 (1000)	312 (1400)
	.775 (19.7)	.951 (23.2)	.118-.375 (3.0-9.5)	AD 66 ALS LF							
	.925 (23.5)	1.040 (26.4)	.197-.469 (5.0-12.0)	ACD 616 ASM LF12							
	.925 (23.5)	1.040 (26.4)	.197-.469 (5.0-12.0)	ACD 616 ASM LF14							

POP® Brand Rivets In Automotive Applications





POP®

Closed End Rivets

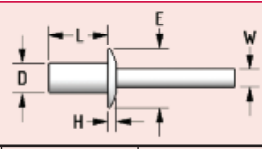
Nominal Rivet Diameter	(L) Nominal Rivet Body Length	Grip Range	Rivet Part Number	Hole Size					Shear Strength	Tensile Strength
					(D) Body Diameter	(H) Flange Thickness	(E) Flange Diameter	(W) Nominal Mandrel Diameter		
In. (mm)	In. (mm)	In. (mm)		In. (mm)	In. (mm)	In. (mm)	In. (mm)	In. (mm)	Lbs. (N)	Lbs. (N)
1100 Aluminum Body/Aluminum Mandrel – Domed Head – Finish: Plain/Plain										
1/8 <i>(3.2)</i>	.237 <i>(6.0)</i>	.032-.062 <i>(.8-1.6)</i>	AD 41 AH	.129-.133 <i>(3.28-3.38)</i>	.124-.128 <i>(3.15-3.25)</i>	.031-.051 <i>(0.79-1.30)</i>	.224-.248 <i>(5.69-6.30)</i>	.072 <i>(1.83)</i>	105 <i>(467)</i>	150 <i>(667)</i>
	.301 <i>(7.7)</i>	.063-.125 <i>(1.6-3.2)</i>	AD 42 AH							
	.362 <i>(9.2)</i>	.126-.187 <i>(3.2-4.8)</i>	AD 43 AH							
	.425 <i>(10.8)</i>	.188-.250 <i>(4.8-6.4)</i>	AD 44 AH							
5/32 <i>(4.0)</i>	.440 <i>(11.2)</i>	.188-.250 <i>(4.8-6.4)</i>	AD 54 AH	.160-.164 <i>(4.06-4.17)</i>	.154-.159 <i>(3.91-4.04)</i>	.046-.066 <i>(1.17-1.68)</i>	.297-.327 <i>(7.54-8.31)</i>	.090 <i>(2.29)</i>	155 <i>(689)</i>	240 <i>(1067)</i>
	.502 <i>(12.8)</i>	.251-.312 <i>(6.4-7.9)</i>	AD 55 AH							
3/16 <i>(4.8)</i>	.330 <i>(8.4)</i>	.063-.125 <i>(1.6-3.2)</i>	AD 62 AH	.192-.196 <i>(4.88-4.98)</i>	.186-.191 <i>(4.72-4.85)</i>	.061-.081 <i>(1.55-2.06)</i>	.357-.393 <i>(9.07-9.98)</i>	.108 <i>(2.74)</i>	220 <i>(978)</i>	310 <i>(1378)</i>
	.455 <i>(11.6)</i>	.126-.250 <i>(3.2-6.4)</i>	AD 64 AH							
	.580 <i>(14.7)</i>	.251-.375 <i>(6.4-7.9)</i>	AD 66 AH							
	.705 <i>(17.9)</i>	.376-.500 <i>(9.5-12.7)</i>	AD 68 AH							

**POP® Brand Rivets
In
Lawn and Garden
Applications**



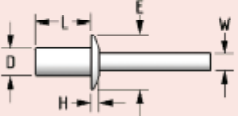

Nominal Rivet Diameter	(L) Nominal Rivet Body Length	Grip Range	Rivet Part Number	Hole Size					Shear Strength	Tensile Strength
					(D) Body Diameter	(H) Flange Thickness	(E) Flange Diameter	(W) Nominal Mandrel Diameter		
In. (mm)	In. (mm)	In. (mm)		In. (mm)	In. (mm)	In. (mm)	In. (mm)	In. (mm)	Lbs. (N)	Lbs. (N)
5056 Aluminum Body/Steel Mandrel – Domed Head – Finish: Plain/Protective Coating										
1/8 <i>(3.2)</i>	.237 <i>(6.0)</i>	.032-.062 <i>(.8-1.6)</i>	AD 41 H	.129-.133 <i>(3.28-3.38)</i>	.124-.128 <i>(3.15-3.25)</i>	.031-.051 <i>(0.79-1.30)</i>	.224-.248 <i>(5.69-6.30)</i>	.064 <i>(1.63)</i>	305 <i>(1356)</i>	385 <i>(1712)</i>
	.301 <i>(7.7)</i>	.063-.125 <i>(1.6-3.2)</i>	AD 42 H							
	.362 <i>(9.2)</i>	.126-.187 <i>(3.2-4.8)</i>	AD 43 H							
	.425 <i>(10.8)</i>	.188-.250 <i>(4.8-6.4)</i>	AD 44 H							
	.487 <i>(12.4)</i>	.251-.312 <i>(6.4-7.9)</i>	AD 45 H							
	.550 <i>(14.0)</i>	.313-.375 <i>(7.9-9.5)</i>	AD 46 H							
	.675 <i>(17.2)</i>	.376-.500 <i>(9.5-12.7)</i>	AD 48 H							
5/32 <i>(4.0)</i>	.315 <i>(8.0)</i>	.063-.125 <i>(1.6-3.2)</i>	AD 52 H	.160-.164 <i>(4.06-4.17)</i>	.154-.159 <i>(3.91-4.04)</i>	.046-.066 <i>(1.17-1.68)</i>	.297-.327 <i>(7.54-8.31)</i>	.086 <i>(2.18)</i>	430 <i>(1912)</i>	605 <i>(2691)</i>
	.377 <i>(9.6)</i>	.126-.187 <i>(3.2-4.8)</i>	AD 53 H							
	.440 <i>(11.2)</i>	.188-.250 <i>(4.8-6.4)</i>	AD 54 H							
	.502 <i>(12.8)</i>	.251-.312 <i>(6.4-7.9)</i>	AD 55 H							
3/16 <i>(4.8)</i>	.330 <i>(8.4)</i>	.063-.125 <i>(1.6-3.2)</i>	AD 62 H	.192-.196 <i>(4.88-4.98)</i>	.186-.191 <i>(4.72-4.85)</i>	.061-.081 <i>(1.55-2.06)</i>	.357-.393 <i>(9.07-9.98)</i>	.104 <i>(2.64)</i>	575 <i>(2557)</i>	840 <i>(3736)</i>
	.392 <i>(10.0)</i>	.126-.187 <i>(3.2-4.8)</i>	AD 63 H							
	.455 <i>(11.6)</i>	.188-.250 <i>(4.8-6.4)</i>	AD 64 H							
	.517 <i>(13.1)</i>	.251-.312 <i>(6.4-7.9)</i>	AD 65 H							
	.580 <i>(14.7)</i>	.313-.375 <i>(7.9-9.5)</i>	AD 66 H							
	.705 <i>(17.9)</i>	.376-.500 <i>(9.5-12.7)</i>	AD 68 H							
1/4 <i>(6.4)</i>	.485 <i>(12.3)</i>	.126-.250 <i>(3.2-6.4)</i>	AD 84 H	.257-.261 <i>(6.53-6.63)</i>	.249-.255 <i>(6.32-6.48)</i>	.079-.099 <i>(2.00-2.51)</i>	.475-.525 <i>(12.06-13.34)</i>	.144 <i>(3.66)</i>	900 <i>(4003)</i>	1100 <i>(4893)</i>
	.610 <i>(15.5)</i>	.251-.375 <i>(6.4-9.5)</i>	AD 86 H							



POP®

Closed End Rivets

Nominal Rivet Diameter	(L) Nominal Rivet Body Length	Grip Range	Rivet Part Number	Hole Size					Shear Strength	Tensile Strength
					(D) Body Diameter	(H) Flange Thickness	(E) Flange Diameter	(W) Nominal Mandrel Diameter		
In. (mm)	In. (mm)	In. (mm)		In. (mm)	In. (mm)	In. (mm)	In. (mm)	In. (mm)	Lbs. (N)	Lbs. (N)
5056 Aluminum Body/Steel Mandrel – Large Flange – Finish: Plain/Protective Coating										
1/8 (3.2)	.262 (6.7)	0-.063 (0-1.6)	AD 402 SBM LF8	.129-.133 (3.28-3.38)	.121-.128 (3.10-3.25)	.027-.047 (0.69-1.19)	.295-.334 (7.49-8.48)	.064 (1.63)	250 Min (1110)	315 Min (1400)
	.324 (8.3)	.063-.125 (1.6-3.2)	AD 404 SBM LF8							
	.387 (9.9)	.125-.188 (3.2-4.8)	AD 406 SBM LF8							
5/32 (4.0)	.332 (8.5)	0-.125 (0-3.2)	AD 504 SBM LF10	.160-.164 (4.06-4.17)	.154-.161 (3.91-4.09)	.047-.067 (1.19-1.70)	.374-.413 (9.50-10.49)	.086 (2.18)	369 Min (1640)	499 Min (2220)
	.394 (10.2)	.125-.188 (3.2-4.8)	AD 506 SBM LF10							
	.461 (11.8)	.188-.250 (4.8-6.4)	AD 508 SBM LF10							
	.523 (13.4)	.250-.309 (6.4-7.9)	AD 510 SBM LF10							
3/16 (4.8)	.348 (8.9)	0-.125 (0-3.2)	AD 604 SBM LF11	.192-.196 (4.88-4.98)	.182-.191 (4.62-4.85)	.056-.076 (1.42-1.93)	.413-.452 (10.49-11.48)	.104 (2.64)	508 Min (2260)	699 Min (3110)
	.410 (10.5)	.125-.188 (3.2-4.8)	AD 606 SBM LF11							
	.473 (12.1)	.188-.250 (4.8-6.4)	AD 608 SBM LF11							
	.527 (13.5)	.250-.309 (6.4-7.9)	AD 610 SBM LF11							
	.590 (15.1)	.309-.371 (7.9-9.5)	AD 612 SBM LF11							

**POP® Brand Rivets
In
Playground Equipment
Applications**



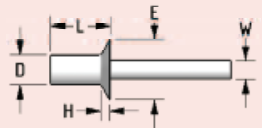
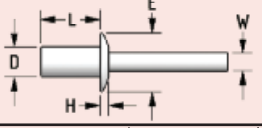

Nominal Rivet Diameter	(L) Nominal Rivet Body Length	Grip Range	Rivet Part Number	Hole Size					Shear Strength	Tensile Strength
					(D) Body Diameter	(H) Flange Thickness	(E) Flange Diameter	(W) Nominal Mandrel Diameter		
In. (mm)	In. (mm)	In. (mm)		In. (mm)	In. (mm)	In. (mm)	In. (mm)	In. (mm)	Lbs. (N)	Lbs. (N)
5056 Aluminum Body/Steel Mandrel – 120° Countersunk – Finish: Plain/Protective Coating										
1/8 <i>(3.2)</i>	.277 <i>(7.0)</i>	.031-.062 <i>(.8-1.6)</i>	AK 41 H	.129-.133 <i>(3.28-3.38)</i>	.124-.128 <i>(3.15-3.25)</i>	.055 Max <i>(1.40)</i>	.221-.245 <i>(5.61-6.22)</i>	.064 <i>(1.63)</i>	305 <i>(1358)</i>	385 <i>(1712)</i>
	.341 <i>(8.7)</i>	.063-.125 <i>(1.6-3.2)</i>	AK 42 H							
	.402 <i>(10.2)</i>	.126-.187 <i>(3.2-4.8)</i>	AK 43 H							
	.466 <i>(11.8)</i>	.188-.250 <i>(4.8-6.4)</i>	AK 44 H							
	.528 <i>(13.4)</i>	.251-.312 <i>(6.4-7.9)</i>	AK 45 H							
	.591 <i>(15.0)</i>	.313-.375 <i>(7.9-9.5)</i>	AK 46 H							
5/32 <i>(4.0)</i>	.307 <i>(7.8)</i>	.032-.062 <i>(1.6-3.2)</i>	AK 51 H	.160-.164 <i>(4.06-4.17)</i>	.155-.159 <i>(3.94-4.04)</i>	.065 Max <i>(1.65)</i>	.297-.327 <i>(7.54-8.31)</i>	.086 <i>(2.18)</i>	430 <i>(1913)</i>	605 <i>(2691)</i>
	.370 <i>(9.4)</i>	.063-.125 <i>(3.2-4.8)</i>	AK 52 H							
	.432 <i>(11.0)</i>	.126-.187 <i>(4.8-6.4)</i>	AK 53 H							
	.475 <i>(12.6)</i>	.251-.312 <i>(6.4-7.9)</i>	AK 55 H							
	.558 <i>(14.2)</i>	.313-.375 <i>(7.9-9.5)</i>	AK 56 H							
3/16 <i>(4.8)</i>	.395 <i>(10.0)</i>	.063-.125 <i>(1.6-3.2)</i>	AK 62 H	.192-.196 <i>(4.88-4.98)</i>	.186-.191 <i>(4.72-4.85)</i>	.075 Max <i>(1.91)</i>	.355-.395 <i>(9.02-10.03)</i>	.104 <i>(2.64)</i>	575 <i>(2558)</i>	840 <i>(3736)</i>
	.520 <i>(13.2)</i>	.126-.250 <i>(3.2-6.4)</i>	AK 64 H							
	.645 <i>(16.4)</i>	.251-.375 <i>(6.4-9.5)</i>	AK 66 H							
Nominal Rivet Diameter	(L) Nominal Rivet Body Length	Grip Range	Rivet Part Number	Hole Size					Shear Strength	Tensile Strength
					(D) Body Diameter	(H) Flange Thickness	(E) Flange Diameter	(W) Nominal Mandrel Diameter		
In. (mm)	In. (mm)	In. (mm)		In. (mm)	In. (mm)	In. (mm)	In. (mm)	In. (mm)	Lbs. (N)	Lbs. (N)
5056 Aluminum Body/Stainless Steel Mandrel – Domed Head – Finish: Plain/Plain										
3/16 <i>(4.8)</i>	.330 <i>(8.4)</i>	.063-.125 <i>(1.6-3.2)</i>	AD 62 SSH	.192-.196 <i>(4.88-4.98)</i>	.186-.191 <i>(4.72-4.85)</i>	.061-.081 <i>(1.55-2.06)</i>	.357-.393 <i>(9.07-9.98)</i>	.104 <i>(2.64)</i>	575 <i>(2559)</i>	840 <i>(3738)</i>
	.455 <i>(11.6)</i>	.126-.250 <i>(3.2-6.4)</i>	AD 64 SSH							
	.580 <i>(14.7)</i>	.251-.375 <i>(6.4-9.5)</i>	AD 66 SSH							
	.705 <i>(17.9)</i>	.376-.500 <i>(9.5-12.7)</i>	AD 68 SSH							



POP[®]



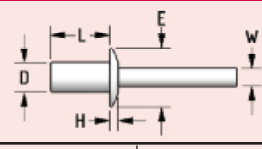

Closed End Rivets

Nominal Rivet Diameter	(L) Nominal Rivet Body Length	Grip Range	Rivet Part Number	Hole Size					Shear Strength	Tensile Strength
					(D) Body Diameter	(H) Flange Thickness	(E) Flange Diameter	(W) Nominal Mandrel Diameter		
In. (mm)	In. (mm)	In. (mm)		In. (mm)	In. (mm)	In. (mm)	In. (mm)	In. (mm)	Lbs. (N)	Lbs. (N)
300 Stainless Steel Body/Stainless Steel Mandrel – Domed Head – Finish: Plain/Plain										
1/8 (3.2)	.260 (6.6)	0-.063 (0-1.6)	SSD 41 SSH	.130-.134 (3.30-3.40)	.122-.128 (3.10-3.25)	.019-.039 (0.48-.99)	.238-.262 (6.05-6.66)	.078 (2.0)	472 (2100)	499 (2220)
	.315 (8.0)	.063-.125 (1.6-3.2)	SSD 42 SSH							
	.382 (9.7)	.125-.190 (3.2-4.8)	SSD 43 SSH							
	.445 (11.3)	.188-.252 (4.8-6.4)	SSD 44 SSH							
	.508 (12.9)	.250-.311 (6.4-7.9)	SSD 45 SSH							
5/32 (4.0)	.339 (8.6)	0-.125 (0-3.2)	SSD 52 SSH	.161-.165 (4.09-4.19)	.153-.159 (3.89-4.04)	.022-.042 (0.56-1.07)	.308-.338 (7.82-8.59)	.093 (2.4)	742 (3300)	899 (4000)
	.402 (10.2)	.125-.190 (3.2-4.8)	SSD 53 SSH							
	.465 (11.8)	.188-.252 (4.8-6.4)	SSD 54 SSH							
	.528 (13.4)	.250-.311 (6.4-7.9)	SSD 55 SSH							
3/16 (4.8)	.362 (9.2)	0-.125 (0-3.2)	SSD 62 SSH	.193-.197 (4.90-5.00)	.184-.190 (4.67-4.83)	.029-.049 (0.74-1.25)	.357-.393 (9.07-9.98)	.117 (3.0)	966 (4300)	990 (4400)
	.425 (10.8)	.125-.189 (3.2-4.8)	SSD 63 SSH							
	.492 (12.5)	.188-.252 (4.8-6.4)	SSD 64 SSH							
	.610 (15.5)	.250-.374 (6.4-9.5)	SSD 66 SSH							
	.728 (18.5)	.371-.500 (9.5-12.7)	SSD 68 SSH							
110 Copper Body/Steel Mandrel – Domed Head – Finish: Plain/Protective Coating										
1/8 (3.2)	.362 (9.2)	.126-.187 (3.2-4.8)	CD 43 H	.129-.133 (3.28-3.38)	.124-.128 (3.15-3.25)	.031-.051 (0.79-1.30)	.224-.248 (5.69-6.30)	.064 (1.63)	270 (1202)	335 (1490)
	.425 (10.8)	.188-.250 (4.8-6.4)	CD 44 H							
	.487 (12.4)	.251-.312 (6.4-7.9)	CD 45 H							



Pull-Thru (PT) Rivets

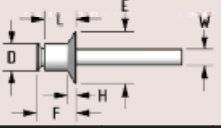

Nominal Rivet Diameter	(L) Nominal Rivet Body Length	(F) Nominal Blind Side Protrusion	 Grip Range	Rivet Part Number	 Hole Size					 Shear Strength	 Tensile Strength
						(D) Body Diameter	(H) Flange Thickness	(E) Flange Diameter	(W) Nominal Mandrel Diameter		
In. (mm)	In. (mm)	In. (mm)	In. (mm)		In. (mm)	In. (mm)	In. (mm)	In. (mm)	In. (mm)	Lbs. (N)	Lbs. (N)
C1006-C1010 Steel Body/Steel Mandrel – 120° Countersunk – Finish: Zinc/Protective Coating											
1/8 <i>(3.0)</i>	.098 <i>(2.5)</i>	.193 <i>(4.9)</i>	.059-.079 <i>(1.5-2.0)</i>	SKK 3025 PT	<i>(3.28-3.40)</i>	<i>(2.90-3.07)</i>	<i>(0.76-0.99)</i>	<i>(4.90-5.49)</i>	<i>(1.83)</i>	<i>(800)</i>	<i>(700)</i>
	.110 <i>(2.8)</i>	.205 <i>(5.2)</i>	.079-.098 <i>(2.0-2.5)</i>	SKK 3030 PT							
	.130 <i>(3.3)</i>	.224 <i>(5.7)</i>	.098-.118 <i>(2.5-3.0)</i>	SKK 3035 PT							
	.150 <i>(3.8)</i>	.244 <i>(6.2)</i>	.118-.138 <i>(3.0-3.5)</i>	SKK 3040 PT							
	.169 <i>(4.3)</i>	.264 <i>(6.7)</i>	.138-.157 <i>(3.5-4.0)</i>	SKK 3045 PT							
	.189 <i>(4.8)</i>	.283 <i>(7.2)</i>	.157-.177 <i>(4.0-4.5)</i>	SKK 3050 PT							
	.209 <i>(5.3)</i>	.303 <i>(7.7)</i>	.177-.197 <i>(4.5-5.0)</i>	SKK 3055 PT							
	.228 <i>(5.8)</i>	.323 <i>(8.2)</i>	.197-.217 <i>(5.0-5.5)</i>	SKK 3060 PT							
	.248 <i>(6.3)</i>	.343 <i>(8.7)</i>	.217-.236 <i>(5.5-6.0)</i>	SKK 3065 PT							

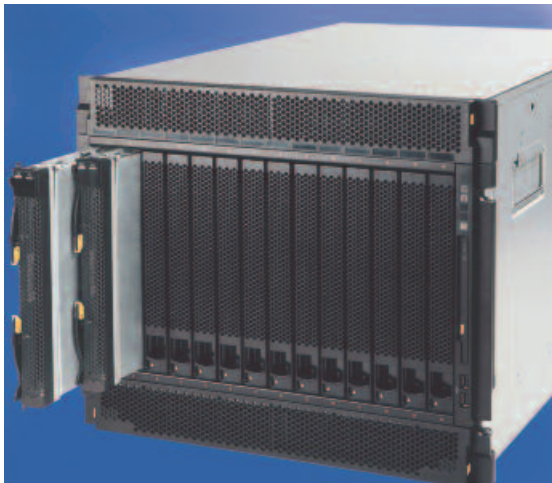

POP® Brand Rivets In Electronics Applications

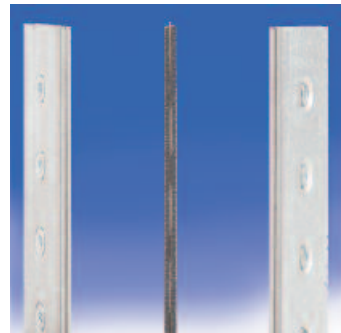

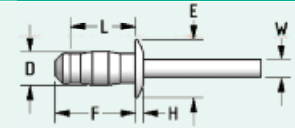

POP®
HS Rivets

Nominal Rivet Diameter	(L) Nominal Rivet Body Length	(F) Nominal Blind Side Protrusion	Grip Range	Rivet Part Number	Hole Size					Shear Strength	Tensile Strength
						(D) Body Diameter	(H) Flange Thickness	(E) Flange Diameter	(W) Nominal Mandrel Diameter		
In. (mm)	In. (mm)	In. (mm)	In. (mm)		In. (mm)	In. (mm)	In. (mm)	In. (mm)	In. (mm)	Lbs. (N)	Lbs. (N)
C1006-C1010 Steel Body/Steel Mandrel – Domed Head – Finish: Zinc/Protective Coating											
1/4 (6.4)	.449 (11.4)	.626 (15.9)	.110-.189- (2.8-4.8)	SD 848 HS	.260-.276 (6.60-7.00)	.248-.259 (6.30-6.57)	.102-.118 (2.60-3.00)	.492-.531 (12.5-13.5)	.158 (4.01)	2700 (12000)	2025 (9000)
	.472 (12.0)	.610 (16.5)	.134-.213 (3.4-5.4)	SD 854 HS							
	.528 (13.4)	.705 (17.9)	.189-.268 (4.8-6.8)	SD 868 HS							
	.606 (15.4)	.783 (19.9)	.268-.346 (6.8-8.8)	SD 888 HS							
5056 Aluminum Body/Aluminum Mandrel – Domed Head – Finish: Plain/Plain											
1/4 (6.4)	.472 (12.0)	.650 (16.5)	.142-.220 (3.6-5.6)	AD 856 AHS	.260-.272 (6.60-6.90)	.248-.259 (6.30-6.57)	.102-.118 (2.60-3.00)	.492-.531 (12.5-13.5)	.158 (4.01)	921 (4100)	787 (3500)



**POP® Brand Rivets
In
Automotive Applications**

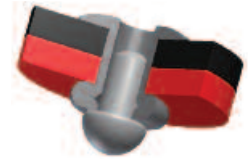



Nominal Rivet Diameter	(L) Nominal Rivet Body Length	(F) Nominal Blind Side Protrusion	Grip Range	Rivet Part Number	Hole Size	Dimensions				Shear Strength	Tensile Strength
						(D) Body Diameter	(H) Flange Thickness	(E) Flange Diameter	(W) Nominal Mandrel Diameter		
In. (mm)	In. (mm)	In. (mm)	In. (mm)		In. (mm)	In. (mm)	In. (mm)	In. (mm)	In. (mm)	Lbs. (N)	Lbs. (N)
Carbon Steel Body/Steel Mandrel – Domed Head – Finish: Zinc/Protective Coating*											
1/8 (3.2)	.318 (8.08)	.414 (10.52)	.063-.125 (1.6-3.2)	SD 42 HT	.133-.141 (3.4-3.6)	.125-.131 (3.18-3.33)	.049 (1.24)	.240-.264 (6.10-6.71)	0.084 (2.13)	326 (1450)	382 (1700)
	.381 (9.68)	.477 (12.12)	.125-.187 (3.2-4.8)	SD 43 HT							
	.444 (11.28)	.540 (13.72)	.187-.250 (4.8-6.4)	SD 44 HT							
5/32 (4.0)	.357 (9.07)	.468 (11.89)	.063-.125 (1.6-3.2)	SD 52 HT	.165-.173 (4.2-4.4)	.156-.164 (3.96-4.17)	.065 (1.65)	.300-.330 (7.62-8.38)	.106 (2.7)	449 (2000)	584 (2600)
	.421 (10.69)	.529 (13.44)	.125-.187 (3.2-4.8)	SD 53 HT							
	.484 (12.29)	.592 (15.04)	.187-.250 (4.8-6.4)	SD 54 HT							
3/16 (4.8)	.365 (9.27)	.490 (12.45)	.063-.125 (1.6-3.2)	SD 62 HT	.197-.212 (5.0-5.4)	.187-.195 (4.75-4.95)	.080 (2.03)	.363-.393 (9.22-9.98)	.132 (3.4)	696 (3100)	764 (3400)
	.426 (10.82)	.553 (14.05)	.125-.187 (3.2-4.8)	SD 63 HT							
	.488 (12.41)	.616 (15.65)	.187-.250 (4.8-6.4)	SD 64 HT							
	.551 (14.0)	.679 (17.25)	.250-.312 (6.4-7.9)	SD 65 HT							
	.614 (15.60)	.742 (18.85)	.312-.375 (7.9-9.5)	SD 65 HT							
1/4 (6.4)	.444 (11.3)	.624 (16.0)	.047-.187 (1.2-4.8)	SD 83 HR	.260-.275 (6.60-6.99)	.250-.259 (6.35-6.58)	.090-.106 (2.29-2.69)	.492-.531 (12.50-13.49)	.181 (4.6)	876 (3900)	1202 (5350)
	.570 (14.5)	.755 (19.2)	.187-.312 (4.8-8.0)	SD 85 HR							
Carbon Steel Body/Steel Mandrel – Large Flange – Finish: Zinc/Protective Coating*											
3/16 (4.8)	.365 (9.27)	.490 (12.45)	.063-.125 (1.6-3.2)	SD 62 HT LF	.197-.212 (5.0-5.4)	.187-.195 (4.75-4.95)	.084 (2.13)	.611-.641 (15.52-16.28)	.132 (3.34)	696 (3100)	764 (3400)
	.426 (10.82)	.533 (14.05)	.125-.187 (3.2-4.8)	SD 63 HT LF							
	.488 (12.41)	.616 (15.65)	.187-.250 (4.8-6.4)	SD 64 HT LF							
	.551 (14.0)	.679 (17.25)	.250-.312 (6.4-7.9)	SD 65 HT LF							
	.614 (15.60)	.742 (18.85)	.312-.375 (7.9-9.5)	SD 66 HT LF							
1/4 (6.4)	.444 (11.3)	.624 (16.0)	.047-.187 (1.2-4.8)	SD 83 HR LF	.250-.258 (6.35-6.55)	.250-.259 (6.35-6.58)	.110-.126 (2.79-3.20)	.610-.649 (15.50-16.48)	.181 (4.6)	876 (3900)	1202 (5350)
	.570 (14.5)	.755 (19.2)	.187-.312 (4.8-8.0)	SD 85 HR LF							

* 1/4" series are HR rivets and have zinc/zinc finish.



Nominal Rivet Diameter	(L) Nominal Rivet Body Length	(F) Nominal Blind Side Protrusion	Grip Range	Rivet Part Number	Hole Size					Shear Strength	Tensile Strength
						(D) Body Diameter	(H) Flange Thickness	(E) Flange Diameter	(W) Nominal Mandrel Diameter		
In. (mm)	In. (mm)	In. (mm)	In. (mm)		In. (mm)	In. (mm)	In. (mm)	In. (mm)	In. (mm)	Lbs. (N)	Lbs. (N)
Carbon Steel Body/Steel Mandrel – 120° Countersunk – Finish: Zinc/Zinc											
1/8 (3.2)	.315 (8.0)	.440 (11.2)	.078-.125 (2.0-3.2)	SK 42 HR	.133-.138 (3.38-3.51)	.124-.133 (3.15-3.35)	.023-.039 (0.58-0.99)	.196-.220 (4.98-5.59)	.087 (2.2)	213 (950)	269 (1200)
	.378 (9.6)	.503 (12.8)	.125-.187 (3.2-4.8)	SK 43 HR							
5/32 (4.0)	.354 (9.0)	.492 (12.5)	.078-.125 (2.0-3.2)	SK 52 HR	.165-.169 (4.19-4.29)	.155-.164 (3.94-4.17)	.031-.047 (0.79-1.19)	.240-.263 (6.10-6.68)	.110 (2.8)	292 (1300)	449 (2000)
	.417 (10.6)	.555 (14.1)	.125-.187 (3.2-4.8)	SK 53 HR							
	.480 (12.2)	.618 (15.7)	.187-.250 (4.8-6.4)	SK 54 HR							
3/16 (4.8)	.425 (10.8)	.555 (15.1)	.093-.187 (2.4-4.8)	SK 63 HR	.196-.205 (4.98-5.21)	.187-.195 (4.75-4.95)	.043-.059 (1.09-1.50)	.307-.338 (7.80-8.59)	.134 (3.4)	696 (3100)	764 (3400)
	.488 (12.4)	.657 (16.7)	.187-.250 (4.8-6.4)	SK 64 HR							
Nominal Rivet Diameter	(L) Nominal Rivet Body Length	(F) Nominal Blind Side Protrusion	Grip Range	Rivet Part Number	Hole Size					Shear Strength	Tensile Strength
						(D) Body Diameter	(H) Flange Thickness	(E) Flange Diameter	(W) Nominal Mandrel Diameter		
Stainless Steel Body/Stainless Steel Mandrel – Domed Head – Finish: Plain/Plain											
1/8 (3.2)	.315 (8.0)	.441 (11.2)	.063-.126 (1.6-3.2)	SSD 42 SSHR	.134-.142 (3.4-3.6)	.124-.133 (3.15-3.35)	.039-.051 (0.99-1.3)	.240-.264 (6.10-6.71)	.087 (2.2)	427 (1900)	562 (2500)
	.378 (9.6)	.503 (12.8)	.126-.189 (3.2-4.8)	SSD 43 SSHR							
	.441 (11.2)	.567 (14.4)	.189-.252 (4.8-6.4)	SSD 44 SSHR							
5/32 (4.0)	.354 (9.0)	.492 (12.5)	.063-.126 (1.6-3.2)	SSD 52 SSHR	.165-.173 (4.19-4.29)	.155-.164 (3.94-4.17)	.055-.066 (1.40-1.68)	.303-.327 (7.70-8.31)	.110 (2.8)	630 (2800)	855 (3800)
	.417 (10.6)	.555 (14.1)	.126-.189 (3.2-4.8)	SSD 53 SSHR							
	.480 (12.2)	.618 (15.7)	.189-.252 (4.8-6.4)	SSD 54 SSHR							
3/16 (4.8)	.362 (9.2)	.545 (13.9)	.063-.125 (1.6-3.2)	SSD 62 SSHR	.196-.212 (4.98-5.38)	.187-.195 (4.75-4.95)	.066-.082 (1.68-2.08)	.362-.396 (9.20-10.06)	.134 (3.4)	1056 (4700)	1124 (5000)
	.425 (10.8)	.610 (15.5)	.125-.187 (3.2-4.8)	SSD 63 SSHR							
	.488 (12.8)	.673 (17.1)	.187-.250 (4.8-6.4)	SSD 64 SSHR							
Nominal Rivet Diameter	(L) Nominal Rivet Body Length	(F) Nominal Blind Side Protrusion	Grip Range	Rivet Part Number	Hole Size					Shear Strength	Tensile Strength
						(D) Body Diameter	(H) Flange Thickness	(E) Flange Diameter	(W) Nominal Mandrel Diameter		
Stainless Steel Body/Stainless Steel Mandrel – 120° Countersunk – Finish: Plain/Plain											
3/16 (4.8)	.425 (10.8)	.555 (15.1)	.094-.187 (2.4-4.8)	SSK 63 SSHR	.196-.205 (4.98-5.21)	.187-.195 (4.75-4.95)	.043-.059 (1.09-1.50)	.307-.338 (7.80-8.59)	.134 (3.4)	831 (3700)	1124 (5000)
	.488 (12.4)	.657 (16.7)	.187-.250 (4.8-6.4)	SSK 64 SSHR							

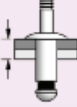
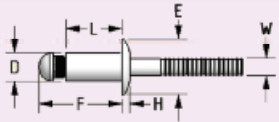





Nominal Rivet Diameter	(L) Nominal Rivet Body Length	(F) Nominal Blind Side Protrusion	 Grip Range	Rivet Part Number	 Hole Size					 Shear Strength	 Tensile Strength
						(D) Body Diameter	(H) Flange Thickness	(E) Flange Diameter	(W) Nominal Mandrel Diameter		
In. (mm)	In. (mm)	In. (mm)	In. (mm)		In. (mm)	In. (mm)	In. (mm)	In. (mm)	In. (mm)	Lbs. (N)	Lbs. (N)
C1006-C1010 Steel Body/Steel Mandrel – Domed Head – Finish: Zinc/Zinc											
1/8 (3.2)	.250 (6.4)	.452 (11.5)	.063-.125 (1.6-3.1)	SD 42 SP.093	.129-.133 (3.28-3.38)	.122-.128 (3.10-3.25)	.031-.041 (0.79-1.04)	.238-.262 (6.05-6.66)	.076 (1.93)	450 (2001)	350 (1556)
	.329 (8.4)	.528 (13.4)	.150-.195 (3.8-4.9)	SD 43 SP.165							
	.391 (19.93)	.590 (15.0)	.185-.240 (4.6-6.0)	SD 44 SP.185							
	.507 (12.9)	.706 (17.9)	.312-.360 (7.9-9.1)	SD 46 SP.312							
5/32 (4.0)	.437 (11.1)	.669 (17.0)	.205-.260 (5.2-6.6)	SD 55 SP.218	.160-.164 (4.06-4.17)	.152-.158 (3.86-4.01)	.040-.050 (1.02-1.27)	.296-.328 (7.52-8.33)	.095 (2.41)	525 (2335)	500 (2224)
	.562 (14.3)	.794 (20.2)	.241-.368 (6.1-9.3)	SD 56 SP.241							
3/16	.315 (8.0)	.612 (13.8)	.062-.125 (1.5-3.1)	SD 62 SP.093	.192-.196 (4.88-4.98)	.183-.191 (4.65-4.85)	.045-.058 (1.14-1.47)	.355-.393 (9.02-9.98)	.114 (2.90)	900 (4005)	700 (3113)
	.378 (9.6)	.668 (17.0)	.065-.187 (1.6-4.7)	SD 63 SP.130							
	.440 (11.2)	.702 (17.8)	.181-.272 (4.6-6.9)	SD 64 SP.220							
	.700 (17.7)	.950 (24.1)	.376-.500 (9.6-12.7)	SD 68 SP.437							
1/4 (6.4)	.365 (9.3)	.650 (16.5)	.062-.125 (1.5-3.1)	SD 82 SP.093	.257-.261 (6.53-6.63)	.249-.255 (6.32-6.48)	.066-.076 (1.69-1.95)	.475-.525 (12.06-13.34)	.151 (3.84)	1750 (7788)	1400 (6227)
C1006-C1010 Steel Body/Steel Mandrel – Large Flange – Finish: Zinc/Zinc											
5/32 (4.0)	.300 (7.6)	.503 (12.8)	.063-.125 (1.6-3.1)	SD 52 SP LF.093	.160-.164 (4.06-4.17)	.152-.158 (3.86-4.01)	.057-.073 (1.45-1.85)	.448-.488 (11.38-12.40)	.095 (2.41)	525 (2335)	500 (2224)
	.417 (10.6)	.628 (16.0)	.129-.256 (3.3-6.5)	SD 54 SP LF.129							
	.525 (13.3)	.794 (20.17)	.126-.343 (3.2-8.7)	SD 56 SP LF.129							
3/16 (4.8)	.442 (11.2)	.579 (14.7)	.187-.235 (4.7-6.0)	SD 64 SPR LF.187*	.192-.196 (4.88-4.98)	.184-.190 (4.67-4.83)	.071-.091 (1.80-2.31)	.600-.650 (15.24-16.51)	.114 (2.90)	900 (4005)	700 (3113)
	.575 (14.6)	.79 (20.1)	.210-.327 (5.3-8.3)	SD 65 SPR LF.225*							
	.566 (14.4)	.716 (18.1)	.188-.38 (4.7-9.7)	SD 66 SPR LF.210*							
	.566 (14.4)	.716 (18.1)	.210-.375 (5.3-9.3)	SD 66 SPR LF.225*							
	.700 (17.9)	.918 (23.3)	.407-.467 (10.3-11.8)	SD 68 SP LF.225							

(*) R: Recessed Body





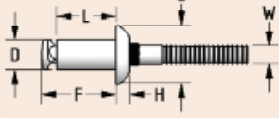





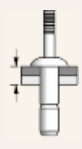

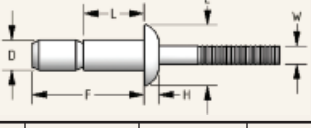

POP®

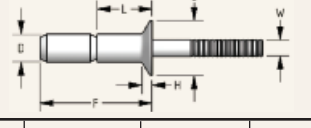
T Rivets

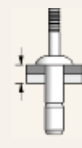
Nominal Rivet Diameter	(L) Nominal Rivet Body Length	(F) Nominal Blind Side Protrusion	 Grip Range	Rivet Part Number	 Hole Size					 Shear Strength	 Tensile Strength
						(D) Body Diameter	(H) Flange Thickness	(E) Flange Diameter	(W) Nominal Mandrel Diameter		
In. (mm)	In. (mm)	In. (mm)	In. (mm)		In. (mm)	In. (mm)	In. (mm)	In. (mm)	In. (mm)	Lbs. (N)	Lbs. (N)
5056 Aluminum Body/Steel Mandrel – Domed Head – Finish: Plain/Zinc											
3/16 (4.8)	.447 (11.4)	.565 (14.4)	.032-.140 (.8-3.6)	AD 6140 TFBS	.192-.196 (4.88-4.98)	.186-.191 (4.72-4.85)	.083-.103 (2.11-2.62)	.375-.405 (9.53-10.29)	.116 (2.95)	950 (4228)	600 (2670)
	.510 (13.0)	.630 (16.0)	.141-.187 (3.6-4.8)	AD 6187 TFBS						1025 (4561)	
	.572 (14.5)	.690 (17.5)	.188-.250 (4.8-6.4)	AD 6250 TFBS						1050 (4670)	
	.635 (16.1)	.755 (19.2)	.251-.312 (6.4-7.9)	AD 6312 TFBS						1125 (5006)	
	.697 (17.7)	.820 (20.8)	.313-.375 (8.0-9.5)	AD 6375 TFBS						1200 (5340)	
	.760 (19.3)	.880 (22.4)	.376-.437 (9.5-11.1)	AD 6437 TFBS						1275 (5674)	
	.822 (20.9)	.940 (23.9)	.438-.519 (11.1-13.2)	AD 6519 TFBS						1350 (6008)	
1/4 (6.4)	.500 (12.7)	.625 (15.9)	.032-.140 (.8-3.6)	AD 8140 TFBS	.257-.261 (6.53-6.63)	.248-.254 (6.30-6.45)	.106-.126 (2.70-3.20)	.485-.535 (12.32-13.59)	.151 (3.84)	1425 (6341)	1110 (4940)
	.552 (14.0)	.710 (18.0)	.141-.187 (3.6-4.8)	AD 8187 TFBS						1575 (7009)	
	.615 (15.6)	.775 (19.7)	.188-.250 (4.8-6.4)	AD 8250 TFBS						1650 (7343)	
	.677 (17.2)	.840 (21.3)	.251-.312 (6.4-7.9)	AD 8312 TFBS						1775 (7899)	
	.740 (18.8)	.900 (22.9)	.313-.375 (8.0-9.5)	AD 8375 TFBS						2050 (9123)	
	.802 (20.4)	.960 (24.4)	.376-.437 (9.5-11.1)	AD 8437 TFBS						2150 (9568)	
	.865 (22.0)	1.025 (26.0)	.437-.519 (11.1-13.2)	AD 8519 TFBS						2325 (10346)	
	.937 (23.8)	1.094 (27.8)	.520-.620 (13.2-15.8)	AD 8620 TFBS						2400 (10680)	
5056 Aluminum Body/Steel Mandrel – Large Flange – Finish: Plain/Zinc											
3/16 (4.8)	.382 (9.7)	.500 (12.7)	.046-.140 (1.2-3.6)	AD 6075 TFBS LF	.192-.196 (4.88-4.98)	.186-.191 (4.72-4.85)	.083-.103 (2.11-2.62)	.543-.583 (13.79-14.81)	.116 (2.95)	950 (4228)	600 (2670)
1/4 (6.4)	.500 (12.7)	.625 (15.9)	.032-.140 (.8-3.6)	AD 8140 TFBS LF	.257-.261 (6.53-6.63)	.248-.254 (6.30-6.45)	.106-.126 (2.70-3.20)	.720-.780 (18.29-19.81)	.151 (3.84)	1425 (6341)	1110 (4940)

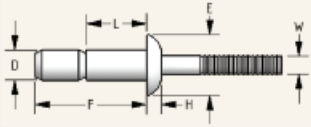

Nominal Rivet Diameter	(L) Maximum Rivet Body Length	(F) Maximum Blind Side Protrusion	 Grip Range	Rivet Part Number	 Hole Size					 Shear Strength	 Tensile Strength
						(D) Body Diameter	(H) Flange Thickness	(E) Flange Diameter	(W) Nominal Mandrel Diameter		
In. (mm)	In. (mm)	In. (mm)	In. (mm)		In. (mm)	In. (mm)	In. (mm)	In. (mm)	In. (mm)	Lbs. (N)	Lbs. (N)
5056 Aluminum Body/Aluminum Mandrel – Domed Head – Finish: Plain/Plain											
3/16 (4.8)	.413 (10.5)	.720 (18.3)	.062-.270 (1.6-6.9)	AD 6270 UG	.191-.201 (4.85-5.11)	.184-.190 (4.67-4.83)	.085 Max (2.16)	.385 Max (9.78)	.118 (3.0)	700 (3113)	500 (2224)
	.572 (14.5)	.880 (22.4)	.214-.437 (5.4-11.1)	AD 6437 UG							
	.572 (14.5)	1.020 (25.9)	.062-.437 (1.6-11.1)	AD 6437 UGX							
1/4 (6.4)	.560 (14.2)	.970 (24.6)	.080-.375 (2.0-9.5)	AD 8375 UG	.261-.272 (6.63-6.91)	.248-.258 (6.30-6.55)	.117 Max (2.97)	.525 Max (13.34)	.158 (4.01)	1300 (5783)	890 (3960)
Nominal Rivet Diameter	(L) Maximum Rivet Body Length	(F) Maximum Blind Side Protrusion	 Grip Range	Rivet Part Number	 Hole Size					 Shear Strength	 Tensile Strength
						(D) Body Diameter	(H) Flange Thickness	(E) Flange Diameter	(W) Nominal Mandrel Diameter		
5056 Aluminum Body/Aluminum Mandrel – 100° Countersunk – Finish: Plain/Plain											
3/16 (4.8)	.486 (12.3)	.795 (20.2)	.125-.331 (3.2-8.4)	AK 6331 UG	.191-.201 (4.85-5.11)	.184-.190 (4.67-4.83)	.080 Max (2.03)	.345 Max (8.76)	.118 (3.0)	700 (3113)	500 (2224)
	.653 (16.6)	.929 (23.6)	.305-.500 (7.8-12.7)	AK 6500 UG							
1/4 (6.4)	.660 (16.8)	1.059 (27.9)	.160-.475 (4.1-12.1)	AK 8475 UG	.261-.272 (6.63-6.91)	.248-.258 (6.30-6.55)	.079 Max (2.01)	.405 Max (10.29)	.158 (4.01)	1300 (5783)	890 (3690)
Nominal Rivet Diameter	(L) Maximum Rivet Body Length	(F) Maximum Blind Side Protrusion	 Grip Range	Rivet Part Number	 Hole Size					 Shear Strength	 Tensile Strength
						(D) Body Diameter	(H) Flange Thickness	(E) Flange Diameter	(W) Nominal Mandrel Diameter		
C1006-C1010 Steel Body/Steel Mandrel – Domed Head – Finish: Zinc/Zinc											
3/16 (4.8)	.415 (10.5)	.743 (18.9)	.062-.270 (1.6-6.9)	SD 6270 UG	.191-.201 (4.85-5.11)	.184-.190 (4.67-4.83)	.085 Max (2.16)	.395 Max (10.03)	.118 (3.00)	1450 (6452)	1200 (5340)
	.582 (14.8)	1.011 (25.7)	.062-.437 (1.6-11.1)	SD 6437 UGX*							
1/4 (6.4)	.560 (14.2)	.999 (25.4)	.080-.375 (2.0-9.5)	SD 8375 UG	.261-.272 (6.63-6.91)	.248-.258 (6.30-6.55)	.117 Max (2.97)	.525 Max (13.34)	.158 (4.01)	2750 (12237)	2200 (9790)
	.810 (20.6)	1.220 (31.0)	.080-.625 (2.0-15.9)	SD 8625 UGX*							

(*) X = Extended Grip Range



POP® Ultra-Grip® Rivets

Nominal Rivet Diameter	(L) Maximum Rivet Body Length	(F) Maximum Blind Side Protrusion	Grip Range	Rivet Part Number	Hole Size	Rivet Dimensions				Shear Strength	Tensile Strength
						(D) Body Diameter	(H) Flange Thickness	(E) Flange Diameter	(W) Nominal Mandrel Diameter		
In. (mm)	In. (mm)	In. (mm)	In. (mm)		In. (mm)	In. (mm)	In. (mm)	In. (mm)	Lbs. (N)	Lbs. (N)	
C1006-C1010 Steel Body/Steel Mandrel – Large Flange – Finish: Zinc/Zinc											
3/16 (4.8)	.415 (10.5)	.710 (18.0)	.062-.270 (1.6-6.9)	SD 6270 UG LF	.191-.201 (4.85-5.12)	.184-190 (4.67-4.83)	.095 Max (2.41)	.533 Max (13.54)	.118 (3.0)	1450 (6450)	1200 (5338)
	.572 (14.5)	.865 (22.0)	.214-.437 (5.4-11.1)	SD 6437 UG LF							
Nominal Rivet Diameter	(L) Maximum Rivet Body Length	(F) Maximum Blind Side Protrusion	Grip Range	Rivet Part Number	Hole Size	Rivet Dimensions				Shear Strength	Tensile Strength
						(D) Body Diameter	(H) Flange Thickness	(E) Flange Diameter	(W) Nominal Mandrel Diameter		
In. (mm)	In. (mm)	In. (mm)	In. (mm)		In. (mm)	In. (mm)	In. (mm)	In. (mm)	Lbs. (N)	Lbs. (N)	
C1006-C1010 Steel Body/Steel Mandrel – 100° Countersunk – Finish: Zinc/Zinc											
3/16 (4.8)	.486 (12.3)	.795 (20.2)	.125-.331 (3.2-8.4)	SK 6331 UG	.191-.201 (4.85-5.12)	.185-.191 (4.70-4.85)	.080 Max (2.03)	.345 Max (8.76)	.118 (3.0)	1450 (6450)	1200 (5330)
1/4 (6.4)	.660 (16.8)	1.059 (27.9)	.160-.475 (4.1-12.1)	SK 8475 UG	.261-.272 (6.63-6.91)	.248-.258 (6.30-6.55)	.079 Max (2.01)	.405 Max (10.29)	.158 (4.01)	2500 (11120)	1850 (8229)
	.910 (23.1)	1.309 (33.2)	.415-.725 (10.5-18.4)	SK 8725 UG							



POP® Brand Rivets In Energy Applications



POP®

Ultra-Grip® Rivets



Nominal Rivet Diameter	(L) Maximum Rivet Body Length	(F) Maximum Blind Side Protrusion	Grip Range	Rivet Part Number	Hole Size	Dimensions				Shear Strength	Tensile Strength
						(D) Body Diameter	(H) Flange Thickness	(E) Flange Diameter	(W) Nominal Mandrel Diameter		
In. (mm)	In. (mm)	In. (mm)	In. (mm)		In. (mm)	In. (mm)	In. (mm)	In. (mm)	In. (mm)	Lbs. (N)	Lbs. (N)
300 Stainless Steel Body/Stainless Steel Mandrel – Domed Head – Finish: Plain/Plain											
3/16 (4.8)	.415 (10.5)	.720 (18.3)	.062-.270 (1.6-6.9)	SSD 6270 UG	.191-.201 (4.85-5.11)	.185-.189 (4.70-4.80)	.099 Max (2.51)	.395 Max (10.03)	.118 (3.0)	1600 (7120)	1100 (4895)
1/4 (6.4)	.560 (14.2)	.995 (25.3)	.080-.375 (2.0-9.5)	SSD 8375 UG	.261-.272 (6.63-6.91)	.248-.258 (6.30-6.55)	.127 Max (3.23)	.525 Max (13.34)	.158 (4.01)	2500 (11125)	2000 (8900)
	.810 (20.6)	1.245 (31.6)	.350-.625 (8.9-15.9)	SSD 8625 UG							
	.810 (20.6)	1.434 (36.4)	.080-.625 (2.0-15.9)	SSD 8625 UGX*							
Nominal Rivet Diameter	(L) Maximum Rivet Body Length	(F) Maximum Blind Side Protrusion	Grip Range	Rivet Part Number	Hole Size	Dimensions				Shear Strength	Tensile Strength
						(D) Body Diameter	(H) Flange Thickness	(E) Flange Diameter	(W) Nominal Mandrel Diameter		
In. (mm)	In. (mm)	In. (mm)	In. (mm)		In. (mm)	In. (mm)	In. (mm)	In. (mm)	In. (mm)	Lbs. (N)	Lbs. (N)
300 Stainless Steel Body/Stainless Steel Mandrel – 100° Countersunk – Finish: Plain/Plain											
3/16 (4.8)	.486 (12.3)	.762 (19.4)	.125-.331 (3.2-8.4)	SSK 6331 UG	.191-.201 (4.85-5.11)	.184-.190 (4.67-4.83)	.070 Max (1.78)	.345 Max (8.76)	.118 (3.0)	1400 (6230)	1000 (4450)
1/4 (6.4)	.660 (16.8)	1.059 (27.9)	.160-.475 (4.1-12.1)	SSK 8475 UG	.261-.272 (6.63-6.91)	.248-.258 (6.30-6.55)	.085 Max (2.16)	.405 Max (10.29)	.158 (4.01)	2500 (11125)	2000 (8900)

(*) X = Extended Grip Range

**POP® Brand Rivets
In
Transportation
Applications**



Tool Selection Guide

Tool	Rivet Material		Multi-Grip									Closed End			
			Easy Entry						Soft Set						
			Micro	Open End	Soft Set	Open End									
Body	Mandrel	0.078" (2.0mm)	3/32" (2.4mm)	0.098" (2.5mm)	7/64" (2.8mm)	0.118" (3.0mm)	1/8" (3.2mm)	5/32" (4.0mm)	3/16" (4.8mm)	1/4" (6.4mm)	1/8" (3.2mm)	5/32" (4.0mm)	3/16" (4.8mm)	1/4" (6.4mm)	
1600	Aluminum	Aluminum		●	●			●	●	●			●	●	
	Aluminum	Steel	●	●				●	●			●	●		
	Steel	Steel		●				●	●			●	●		
510A 511A 2501 5251A	Aluminum	Aluminum		●				●	●	●			●	●	●
	Aluminum	Steel		●				●	●	●†			●	●	
	Steel	Steel		●				●	●	●†			●	●	
	Monel	Steel				●		●	●						
	Stainless	Steel						●	●				●	●	
	Stainless	Stainless						●	●				●	●	
2500 5250A 5800	Aluminum	Aluminum		●				●	●	●			●	●	●
	Aluminum	Steel		●				●	●	●			●	●	●
	Aluminum	Stainless						●	●	●			●	●	●
	Steel	Steel		●				●	●	●			●	●	●
	Monel	Steel				●		●	●	●					
	Monel	Stainless						●	●	●					
	Stainless	Steel						●	●	●					
540 3400	Aluminum	Aluminum		●				●	●	●	●		●	●	●
	Aluminum	Steel		●				●	●	●	●		●	●	●
	Aluminum	Stainless						●	●	●	●		●	●	●
	Steel	Steel		●				●	●	●	●		●	●	●
	Monel	Steel				●		●	●	●	●		●	●	●
	Monel	Stainless						●	●	●	●				
	Stainless	Steel						●	●	●	●				
	Stainless	Stainless						●	●	●	●	●	●	●	●
Copper	Steel						●	●	●	●	●	●	●	●	

Tool	Rivet Material		Grip Tite & HR												
			Self Plugger				HS	PT	LS & LSR			T Rivet		Ultra-Grip	
			1/8" (3.2mm)	5/32" (4.0mm)	3/16" (4.8mm)	1/4" (6.4mm)	1/4" (6.4mm)	1/8" (3.0-3.2mm)	1/8" (3.2mm)	5/32" (4.0mm)	3/16" (4.8mm)	3/16" (4.8mm)	1/4" (6.4mm)	3/16" (4.8mm)	1/4" (6.4mm)
1600, 510A 511A, 2501 5251A	Aluminum	Aluminum							●	●	●*				
	Steel	Steel	●					●							
2500 5250A 5800	Aluminum	Aluminum							●	●	●			●	
	Aluminum	Steel							●				●		
	Steel	Steel	●	●	●‡				●				●		
540 3400	Stainless	Stainless											●	●	
	Aluminum	Aluminum					●		●	●	●			●	●
	Aluminum	Steel											●	●	
	Steel	Steel	●	●	●	●□	●							●	●
Stainless	Stainless			●									●	●	

(†) Except Multi Grip,

(*) Except ProSet Series 1600

(‡) Use ProSet 2500 Series only for Grip Tite & HR rivets

(□) Use ProSet 3400 Series only for Grip Tite & HR rivets

Hand Tools POPSet®



PS15-CS

PS20

PS25

PS40

PS45

PS15-CS Professional Hand Plier Rivet Tool

- Professional standard, robust cast aluminum and steel design
- Contoured handle grips for comfort
- Rivet retaining handle design for one-handed riveting
- Handle spring and clasp upgrade available separately
- Supplied with nosepieces for 3/32" (2.4mm), 1/8" (3.2mm), 5/32" (4.0mm) and 3/16" (4.8mm) rivets
- Supplied with nosepiece wrench

Specifications

Weight	1.3 lb (0.6 kg)
Length	9.65 in (245 mm)

Rivet Material	Rivet Diameter [in/(mm)]			
	3/32 (2.4)	1/8 (3.0, 3.2)	5/32 (4.0)	3/16 (4.8)

Aluminum	•	•	•	•
-----------------	---	---	---	---

Steel	•	•	•	
--------------	---	---	---	--

Stainless Steel	•	•	•	
------------------------	---	---	---	--

PS20 Lazy Tong Rivet Tool

- Professional standard, robust aluminum and steel construction
- Supplied with nosepieces for 1/8" (3.2mm), 5/32" (4.0mm), 3/16" (4.8mm), 6.0mm and 1/4" (6.4mm) rivets
- Supplied with nosepiece wrench that doubles as a lever lock

Specifications

Weight	4.6 lb (2.10 kg)
Length closed	12 in (305 mm)
Length extended	31.7 in (805 mm)

Rivet Material	Rivet Diameter [in/(mm)]			
	1/8 (3.0, 3.2)	5/32 (4.0)	3/16 (4.8)	1/4 (6.0, 6.4)

Aluminum	•	•	•	•
-----------------	---	---	---	---

Steel	•	•	•	
--------------	---	---	---	--

Stainless Steel	•	•	•	
------------------------	---	---	---	--

PS25 Heavy Duty Lazy Tong Rivet Tool

- Professional heavy duty grade, robust aluminum and steel construction
- Supplied with nosepieces for 1/8" (3.2mm), 5/32" (4.0mm), 3/16" (4.8mm), 6.0mm and 1/4" (6.4mm) rivets
- Supplied with nosepiece wrench that doubles as a lever lock

Specifications

Weight	5.1 lb (2.30 kg)
Length closed	12 in (305 mm)
Length extended	31.7 in (805 mm)

Rivet Material	Rivet Diameter [in/(mm)]			
	1/8 (3.0, 3.2)	5/32 (4.0)	3/16 (4.8)	1/4 (6.0, 6.4)

Aluminum	•	•	•	•
-----------------	---	---	---	---

Steel	•	•	•	•
--------------	---	---	---	---

Stainless Steel	•	•	•	•
------------------------	---	---	---	---

PS40 Lever Rivet Tool

- Professional standard, robust steel construction
- Long lever tool for optimum pulling force
- Supplied with nosepieces for 1/8" (3.2mm), 5/32" (4.0mm), 3/16" (4.8mm), 6.0mm and 1/4" (6.4mm) rivets
- Supplied with nosepiece wrench
- Integral removable mandrel collector

Specifications

Weight	4.3 lb (1.95 kg)
Length	20.3 in (515 mm)

Rivet Material	Rivet Diameter [in/(mm)]			
	1/8 (3.0, 3.2)	5/32 (4.0)	3/16 (4.8)	1/4 (6.0, 6.4)

Aluminum	•	•	•	•
-----------------	---	---	---	---

Steel	•	•	•	
--------------	---	---	---	--

Stainless Steel	•	•	•	
------------------------	---	---	---	--

PS45 Heavy Duty Lever Rivet Tool

- Telescopic levered high-capacity rivet tool
- Professional standard, heavy duty steel construction
- Two-position telescopic levers extend to maximize leverage and pulling force
- Non-extended position makes tool more compact
- Integral removable mandrel collector
- Supplied with nosepieces for 1/8" (3.2mm), 5/32" (4.0mm), 3/16" (4.8mm), 6.0mm and 1/4" (6.4mm) rivets
- Supplied with nosepiece wrench

Specifications

Weight	5.7 lb (2.60 kg)
Length	19.3 in (490 mm)
Length extended	26.2 in (665 mm)

Rivet Material	Rivet Diameter [in/(mm)]			
	1/8 (3.0, 3.2)	5/32 (4.0)	3/16 (4.8)	1/4 (6.0, 6.4)

Aluminum	•	•	•	•
-----------------	---	---	---	---

Steel	•	•	•	•
--------------	---	---	---	---

Stainless Steel	•	•	•	•
------------------------	---	---	---	---

PS15-KIT Rivet Tool Kit

- Lightweight, professional grade PS15-CS tool
- Contains 200 assorted rivets, 60 back-up plates & wrench
- Accessories include:
 - Nosepieces for 3/32-3/16" (2.4-4.8mm) rivets
 - Jaws for 3/32-3/16" (2.4-4.8mm)
 - Jaw Pusher Spring for 3/32-3/16" (2.4-4.8mm)

Specifications

Weight	1.3 lb (0.6 kg)
Length	9.65 in (245 mm)



PRP26A Sheet Metal Rivet Tool

- Ideal tool for sheet metal, ducting and HVAC jobs
- Offset nosepiece to easy access corners and close to wall applications
- Supplied with nosepiece to set 1/8" (3.2mm) rivets



Specifications

Weight	0.91 lb (0.41 kg)
Length	8.75 in (222 mm)

Rivet Material	Rivet Diameter [in/(mm)]		
	3/32 (2.4)	1/8 (3.0, 3.2)	5/32 (4.0)

Aluminum	•	•	•
-----------------	---	---	---

Steel	•	•	
--------------	---	---	--

Stainless Steel	•		
------------------------	---	--	--

Power Tools

ProSet® 1600

Compact, lightweight and reliable pneumatic/hydraulic power tool, ideal for production line environments.

For setting rivets from 2.0mm and 3/32"-5/32" (2.4-4.0mm). High force to weight ratio and innovative ergonomic design for maximum user efficiency and comfort.

Features & Benefits:

- Lightweight robust construction
- Comfortable two finger, low activation force trigger
- Directionable air exhaust (MCS model)
- Quick disconnect front-end assembly & Mandrel Collection System (MCS)
- Spring return for a reliable fast setting cycle
- Energy saving On/Off, left or right swivel air fitting
- POP® Rivet Presenter compatible
- Suitable for use with POP® Remote Mandrel Collection System (MCS5000)
- Available in deflector or MCS versions
- Air-isolation switch during MCS removal

Specifications

Model Number	ProSet® 1600	ProSet® 1600MCS
Weight	2.14 lb (0.97 kg)	2.29 lb (1.04 kg)
Length	10.83 in (275 mm)	10.71 in (272 mm)
Height	8.94 in (227 mm)	
Tool stroke	0.71 in (18 mm)	
Working air pressure	72.5 - 100 psi (5.0 - 6.9 bar) dry, filtered	
Pulling force	1090 lb @ 90 psi (4850 N @ 6.2 bar)	
Force/Weight ratio	509 lbf/lb (5 kN/kg)	476 lbf/lb (4.6 kN/kg)
Air consumption	0.043 cu. ft/rivet (1.22 liters/rivet)	2.47 scfm (max) [70 liters/min (max)]

Rivet Capacity

Rivet Type	Material (Body-Mandrel)	Rivet Diameter		
		3/32"(*) (2.4 mm)	1/8" (3.0, 3.2 mm)	5/32" (4.0 mm)
Open End & Multi-Grip™	Aluminum-Aluminum	✓	✓	✓
	Aluminum-Steel or St. Steel (**)	✓	✓	✓
	Steel-Steel	✓	✓	✓(†)
	St. Steel-St. Steel;	✓	✓	
	Monel-Steel or St. Steel	✓	✓	
Closed End	Aluminum-Aluminum	✓	✓	✓
	Aluminum-Steel or St. Steel	✓	✓	✓(‡)
	Copper-Steel	✓	✓	
	Steel-Steel	✓	✓	
St. Steel-St. Steel	✓	✓		
LS/LSR Rivets	Aluminum-Aluminum	✓	✓	✓
Grip Tite®/HR®	Steel-Steel		✓	
"T" Rivet	Aluminum-Steel	✓	✓	✓
Self Plugger	Steel-Steel	✓	✓	
Pull-Thru	Steel-Steel		✓	
MCS Collector Capacity (# Mandrels)		300	120	90

(*) Use FAN239-176 Jaw pusher set up; (†) Excludes MultiGrip;
(‡) Set air pressure at 90 psi (6.2 bar). (**) St. Steel - Stainless Steel



Optional Accessories

Part Number	Description
PRN214	Nosepiece for 2.0 mm Micro Rivets
PRG402-02	Jaws for 2.0 mm Micro Rivets
FA203-408	Adaptor Kit for MCS5000 (remote MCS)
FAN239-177	Mandrel Collection System Retrofit Kit
RP4-486	Rivet Presenter Receptacle

Optional Special Front Ends

FAN239-174	Front End 5" Length Extension Kit
------------	-----------------------------------



Extended Nose Housing

ProSet® 2500

Setting a new standard for pneumatic/hydraulic rivet tools.

ProSet 2501 comes with a reduced diameter (.685") and extended (5.3") front end for better access in tight spaces to set 2.0mm to 5/32" (4.0mm) rivets. ProSet 2500 for setting rivets from 1/8" to 3/16" (3.0-4.8mm). High force to weight ratio and innovative ergonomic design for maximum user efficiency and comfort.

Features & Benefits:

- Lightweight robust construction
- Comfortable two finger, low activation force trigger
- Directionable air exhaust (MCS model)
- Quick disconnect front-end assembly & Mandrel Collection System (MCS)
- Energy saving On/Off, left or right swivel air fitting
- Spring return for reliable fast setting cycle
- POP® Rivet Presenter compatible
- Suitable for use with POP® Remote Mandrel Collection System (MCS5000)
- Air isolation during MCS removal
- Available in deflector or MCS versions

Specifications

Model Number	ProSet® 2500	ProSet® 2500MCS
Weight	2.65 lb (1.20 kg)	2.89 lb (1.31 kg)
Length	11.42 in (275 mm)	11.97 in (304 mm)
Height	10.20 in (259 mm)	
Tool stroke	0.71 in (18 mm)	
Working air pressure	72.5 - 100 psi (5.0 - 6.9 bar) dry, filtered	
Pulling force	2110 lb @ 90 psi (9400 N @ 6.2 bar)	
Force/Weight ratio	796.2 lbf/lb (7.83 kN/kg)	730 lbf/lb (7.18 kN/kg)
Air consumption	0.076 cu. ft/rivet (2.15 liters/rivet)	2.47 scfm (max) [70 liters/min (max)]

Rivet Capacity

Rivet Type	Material (Body-Mandrel)	Rivet Diameter		
		1/8"(*) (3.0, 3.2 mm)	5/32"(*) (4.0 mm)	3/16"(**) (4.8 mm)
Open End & Multi-Grip™	Aluminum-Aluminum	✓	✓	✓
	Aluminum-Steel or St. Steel	✓	✓	✓
	Steel-Steel	✓	✓	✓
	St. Steel-St. Steel; Monel-Steel or St. Steel	✓	✓	✓ ^(†)
Closed End	Aluminum-Aluminum	✓	✓	✓
	Aluminum-Steel or St. Steel	✓	✓	✓
	Copper-Steel	✓	✓	✓
	Steel-Steel St. Steel-St. Steel	✓	✓	✓
LS/LSR Rivets	Aluminum-Aluminum	✓	✓	✓
Grip Tite®/HR®	Steel-Steel	✓	✓ ^(**)	✓
"T" Rivet	Aluminum-Steel	✓	✓	✓
Self Plugger	Steel-Steel	✓	✓	✓
Ultra-Grip®	Aluminum-Aluminum			✓
	Steel-Steel			✓
	St. Steel-St. Steel			✓
Pull-Thru	Steel-Steel	✓		



Optional Accessories

Part Number	Description
FAN275-133	ProSet® 2500 Seal kit
FA203-408	Adaptor kit for Remote MCS (MCS5000)
FAN275-134	Mandrel Collection System Retrofit kit
RP4-350	RP4 / RP5 Receptacle
RP6-350	RP6 Receptacle

Optional Special Front Ends

FAN275-132	Front End 5" (140mm) Extension kit for 1/8", 5/32" & 3/16"
FAN275-198	Reduced diameter .686" (17.4mm) Front End Kit for 2mm, 3/32", 1/8" & 5/32" (see note)
FAN275-222	Conversion Kit for 3/16" Aluminum
FAN275-229	Reduced diameter .686" (17.4mm) Front End Kit for 3/16" Aluminum-Steel rivets
PRH830-2500	PRH830 & A1 Head Adaptor
PRH840-2500	PRH840 Corner Head Adaptor



MCS Retrofit Kit

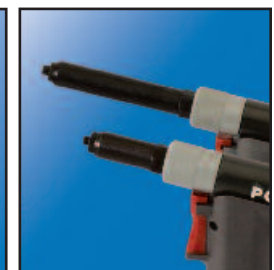

Extended Nose Housing

(*) Use FAN275-028 Jaw pusher set up; (**) Use DPN275-027 Jaw pusher set up.

(†) Excludes Multi-Grip™ St. Steel: Stainless Steel

Note: Standard on ProSet 2501 series 2mm & 3/32" (2.4mm) rivets, use the ProSet 2501. For 2mm, order PRG402-02 jaws and PRN214 nosepiece. For 3/32" (2.4mm), order PRN314 nosepiece.

Power Tools

ProSet® 3400

High capacity pneumatic/hydraulic rivet tool.

Capable of setting the full range of POP® rivets up to 1/4" (6.4mm) Stainless Steel. Includes all of the design features and benefits of the 1600 and 2500.

Features & Benefits:

- Lightweight strong construction
- Comfortable two finger, low activation force trigger
- Directionable air exhaust (MCS model)
- High force-to-weight ratio
- Quick disconnect front-end assembly & Mandrel Collection System (MCS)
- Energy savings On/Off, left or right swivel air fitting
- Spring return for a reliable fast setting cycle
- POP® Rivet Presenter compatible
- Suitable for use with POP® Remote Mandrel Collection System (MCS5000)
- POP® Speciality Heads available
- Air-isolation switch during MCS removal

Specifications

Model Number	ProSet® 3400	ProSet® 3400MCS
Weight	4.19 lb (1.90 kg)	4.41 lb (2.00 kg)
Length	12.17 in (309 mm)	13.15 in (334 mm)
Height	12.44 in (316 mm)	
Tool stroke	1.02 in (26 mm)	
Working air pressure	72.5 - 100 psi (5.0 - 6.9 bar) dry, filtered	
Pulling force	4,160 lb @ 90 psi (18,500 N @ 6.2 bar)	
Force/Weight ratio	993 lbf/lb (9.7 kN/kg)	943 lbf/lb (9.2 kN/kg)
Air consumption	0.172 cu. ft/rivet (4.86 liters/rivet)	2.83 scfm (max) [80 liters/min (max)]

Rivet Capacity

Rivet Type	Material (Body-Mandrel)	Rivet Diameter			
		1/8" (*) (3.0, 3.2 mm)	5/32" (**) (4.0 mm)	3/16" (***) (4.8 mm)	1/4" (†) (6.0, 6.4 mm)
Open End & Multi-Grip™	Al – Al	✓	✓	✓	✓
	Al – St / SS	✓	✓	✓	✓
	St – St	✓	✓	✓	✓
	SS – SS; Mo – St / SS	✓	✓	✓	✓
Closed End	Al – Al	✓	✓	✓	✓
	Al – St / SS; Cu – St	✓	✓	✓	✓
	St – St	✓	✓	✓	✓
SS – SS	✓	✓	✓	✓	
LS/LSR Rivets	Al – Al	✓	✓	✓(†)	NA
"T" Rivet	Al – St	✓	✓	✓(†)	✓
Self Plugger	St – St	✓	✓	✓(†)	✓
Grip Tite®/HR®	St – St	✓	✓	✓(†)	X
HS Rivets	Al – Al; St – St	NA	NA	NA	✓
Ultra-Grip®	Al – Al; St – St; SS – SS	NA	NA	✓(†)	✓

Al: Aluminum, St: Steel, SS: Stainless Steel, Cu: Copper, Mo: Monel
 (*) Use PRG540-46 Jaws with FAN276-064 Jaw Pusher Setup
 (**) Use PRG540-46 Jaws and DPN276-006 Jaw Pusher Setup
 (†) Use PRG540-44 Jaws and DPN276-006 Jaw Pusher Setup



Optional Accessories

Part Number	Description
FA203-408	MCS5000 Adaptor Kit for 4, 5, 6 Size Rivets
FA203-414	MCS5000 Adaptor Kit for 8 Size Rivets
FAN276-152	ProSet® 3400 Seal Kit
FAN276-165	Mandrel Collection System Retrofit Kit
RP4-501	RP4/ RP5 Receptacle
RP6-501	RP6 Receptacle

Optional Special Front Ends

FAN276-075	ProSet® 3400 8" Front End Extension kit
PRH840-3400	PRH840 Corner Head Adaptor
PRH850-3400	PRH850 Corner Head Adaptor



MCS Retrofit Kit

MCS5800L

Cordless rechargeable battery tool.

For setting rivets from 3/32" to 3/16" (2.4 to 4.8mm). Ideal for site and maintenance work and applications where compressed air is not available.

Features & Benefits:

- Tough and solid; built to withstand industrial conditions
- Easy to use, well balanced and comfortable
- Instant return to start position after rivet setting, saves energy and increases productivity
- Sets up to 1900 rivets per charge (35 min to re-charge)
- Included:
 - Interchangeable nosepieces 1/8" (3.2mm), 5/32" (4.0mm) and 3/16" (4.8mm).
 - Nosepiece wrench
 - 14.4V Li-Ion battery
 - Battery charger
 - Steel carry case



Rivet Material	Rivet Diameter [in/(mm)]			
	3/32 (2.4)	1/8 (3.0, 3.2)	5/32 (4.0)	3/16 (4.8)
Aluminum	•	•	•	•
Steel	•	•	•	•
Stainless Steel	•	•	•	•

Specifications

Weight	4.8 lb (2.2 kg)
Length	10.4 in (265 mm)
Height	11.8 in (300 mm)
Stroke	0.79 in (20 mm)

Accessories Included

Part Number	Description
MCS5800-48	Battery 14.4V 1.3 Ah Li-Ion
MCS5800-51S	Battery Charger for Li-Ion

Optional Retaining Nosepieces

Part Number	Rivet
MCS5800-14R	3/32" Open End & 1/8" Al-St Closed End
MCS5800-15R	1/8" Open End & Al-Al Closed End Rivets
MCS5800-16R	5/32" Al-St Closed End Rivets
MCS5800-17R	5/32" Open End & 3/16" Al-St Closed End
MCS5800-18R	3/16" Open End Rivets

Optional Nosepiece

Part Number	Rivet
MCS5800-14	3/32" Open End & 1/8" Al-St Closed End

Power Tools

PRG510A / MCS510A

Robust, heavy duty pneumatic riveting tool for setting up to 3/16" (4.8mm) aluminum rivets. Available in standard style with deflector (PRG) or equipped with Mandrel Collection System (MCS).

Rivet Material	Rivet Diameter [in/(mm)]		
	1/8 (3.0, 3.2)	5/32 (4.0)	3/16 (4.8)

Aluminum	•	•	•
----------	---	---	---

Steel	•	•	
-------	---	---	--

Stainless Steel	•		
-----------------	---	--	--

Specifications

Model Number	Type	510A	511A
Weight	PRG	3.6 lb (1.63 kg)	3.8 lb (1.72 kg)
	MCS	4.0 lb (1.81 kg)	4.1 lb (1.85 kg)
Length	PRG	6.7 in (170 mm)	8.5 in (216 mm)
	MCS	11.3 in (286 mm)	13.5 in (3.43 mm)
Height		9.63 in (244 mm)	
Front end length		2.5 in (64 mm)	4.5 in (114 mm)
Working air pressure		85 psi (5.8 bars)	
Pulling force		1000 lbf (4448N)	
Tool stroke		0.625 in (15.87 mm)	



Note: PRG510A-PLUS includes air line, extra jaws, jaw pusher and spring; PRG510A includes tool only.

PRG540 / MCS540

Robust, heavy duty pneumatic hydraulic riveting tool for setting the full range of POP® rivets.

Rivet Material	Rivet Diameter [in/(mm)]			
	1/8 (3.0, 3.2)	5/32 (4.0)	3/16 (4.8)	1/4 (6.0, 6.4)

Aluminum	•	•	•	•
----------	---	---	---	---

Steel	•	•	•	•
-------	---	---	---	---

Stainless Steel	•	•	•	•
-----------------	---	---	---	---

Specifications

Model Number	Type	540/544	541
Weight	PRG	4.85 lb (2.2 kg)	5.25 lb (2.38 kg)
	MCS	4.96 lb (2.25 kg)	5.39 lb (2.44 kg)
Length	PRG	9.0 in (229 mm)	11.5 in (292 mm)
	MCS	13.5 in (343 mm)	16 in (406 mm)
Height		11.5 in (292.1 mm)	
Front end length		3.5 in (88 mm)	5.9 in (151 mm)
Working air pressure		85 psi (5.8 bars) dry, filtered	
Pulling force		3000 lbf (13,345N)	
Tool stroke		0.685 in (17.4 mm)	



Optional Accessory

Part Number	Description
PRG541-001	Extended 5.5 in (140 mm) Front End Kit

Note: 540 and 541 models are set up for 3/16" (4.8 mm) rivets; 544 model is set up for 1/4" (6.4 mm) rivets.

PRT5250A / MCS5250A

In-Line Pneumatic-Hydraulic rivet tool design for suspension and riveting in a vertical plane.

The MCS5250A system is complete with the remote vacuum mandrel collector MCS5000, (see below). PRT5250A includes tool only.

Specifications

	PRT5250A
Weight	3.9 lb (1.8 kg)
Length	15.62 in (397 mm)
Width	4.44 in (113 mm)
Tool stroke	0.625 in (15.87 mm)
Working air pressure	85 psi (5.8 bars) dry, filtered
Pulling force	1900 lbf (8454N)
Air consumption	0.011 cf/rivet (0.31 l/rivet)

Rivet Material	Rivet Diameter [in/(mm)]		
	1/8 (3.0, 3.2)	5/32 (4.0)	3/16 (4.8)
Aluminum	•	•	•
Steel	•	•	•
Stainless Steel	•	•	•



Optional Accessories

Part Number	Description
MCS5000-5250A	Adaptor for MCS5000
PRT5251-22	4 in (100 mm) Reduced diameter front end

MCS5000

The MCS5000 remote vacuum mandrel collector can hold up to 8500 spent mandrels increasing production line efficiency and promoting easy removal and recycling of scrap mandrels. The MCS5000 is compatible with all pneumatic POP tools. Adapter kits are required and sold separately, (see below).

Specifications

Weight	4.8 lb (2.2kg)
Length	16.3 in (414 mm)
Diameter	14.0 in (356 mm)
Air pressure	90 psi (6.1 bar max.)
Air consumption	12 scfm (317 litres/min)
Max tube length	14.7 ft (4.5 m)
Max rise	5.9 (1.8 m)
Max mandrel length	2 in (50 mm)
Capacity	Up to 8500 spent mandrels

MCS5000 Adapter Kits

Tool	Adapter Kit Part No
ProSet® 1600MCS	FA203-408
ProSet® 2500MCS	FA203-408
ProSet® 3400MCS	FA203-408(*)
MCS510A	MCS5000-510
MCS540/541	MCS5000-540(*)
PRT5250A	MCS5000-5250A ^(†)



(*) Additional kit (Part No MCS5000-6) is required for 1/4" (6.4mm) rivets.

^(†) Adapter included with MSC5250A.

Power Tools

Tool Accessories

Special Front-End Accessories

Where limited access applications make it impossible to use POP® riveting tools in their standard configurations, a series of specialized setting heads and front end kits are available.

A1 Offset Head

Narrow nose diameter, for setting rivets in tight corners

- Head sets rivets within 0.276" (7mm) of a right-angled section
- Recommended for setting POP® rivets up to and including aluminum alloy 3/16" (4.8mm) diameter
- Weight: 1.39lb (0.63 kg)

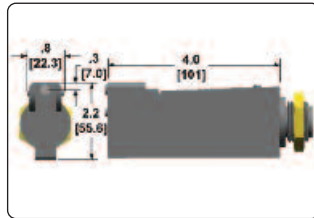

PRH830 Corner Head

Very compact 90° corner head

- Designed for extremely restricted access
- Sets all POP® rivets up to and including aluminum alloy 5/32" (4.0mm) diameter
- Weight: 0.68lb (0.31 kg)

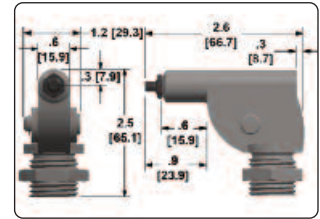

PRH840 Corner Head

Robust 90° corner head

- Suitable for use with wide range of riveting tools
- Recommended for setting POP® rivets up to and including steel 3/16" (4.8mm) diameter
- Weight: 1.1lb (0.5 kg)

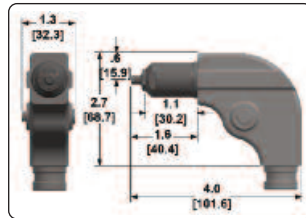

PRH850 Heavy Duty Corner Head

Heavy duty 90° corner head

- Designed for high volume usage with higher capacity POP® setting tools
- Sets all POP® rivets up to and including open end 1/4" (6.4mm) diameter
- Weight: 1.68lb (0.76 kg)

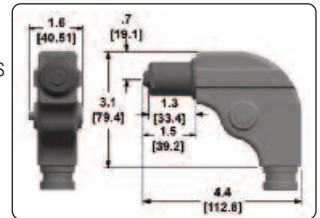

Special Setting Head Kits

Setting Head	Adapter Kits				
Description	ProSet® 1600	ProSet® 2500	ProSet® 3400	510A	540
A1	Not Available	PRH830-2500	—	PRA967	PRA965
PRH830	Not Available	PRH830-2500	—	PRA967	PRA965
PRH840	Not Available	PRH840-2500	PRH840-3400	PRH840-510	PRH840-540
PRH850	Not Available	—	PRH850-3400	—	PRH850-540

Front End Kits

A wide range of front end kits ensures that the POP® setting tool range is able to reliably set rivets even in deep or narrow access applications.

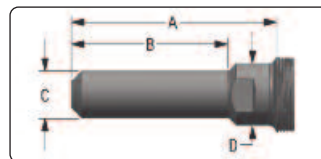

Quick disconnect
Reduced diameter version

Tool Series	Part Number	A		B		C		D	
		in	(mm)	in	(mm)	in	(mm)	in	(mm)
ProSet® 1600	FAN239-174	5.12	130.0	3.78	96.0	0.68	17.3	1.10	28.0
ProSet® 2500	FAN275-132	5.49	139.5	3.78	96.0	0.81	20.6	1.26	32.0
	FAN275-198 (up to 5/32")	5.30	134.5	2.17	55.0	0.68	17.3	1.26	32.0
	FAN275-229 (3/16" Al-St)	5.30	134.5	2.17	55.0	0.68	17.3	1.26	32.0
ProSet® 3400	FAN276-075	7.87	200.0	6.10	155.0	0.88	22.4	1.50	38.0
510A	PRG511-003 (std. set up on 511A)	4.09	103.9	3.00	76.2	0.68	17.4	0.88	22.2
5250A	PRG5201-001 (std. set up on 5251A)	3.38	85.7	1.86	47.1	0.68	17.4	0.90	22.9
540	PRG541-001 (std. set up on 541)	5.60	142.1	3.55	90.1	0.90	22.8	1.25	31.8



Hand Tools

POPSet®

Nosepieces & Jaws

POPSet® Hand Tools are designed to be easily maintained. The full range of spare parts is available - see the POPSet® tool manuals for details. To order replacement nosepieces, jaws and jaw pushers, select from the list below.

	Rivet Diameter		Nosepieces	Jaws	Jaw Pusher
	in	(mm)	Part No	Part No	Part No
PS15-CS	3/32	2.4	DPM400-A08	DPM400-084	DPM400-086
	1/8	3.0 - 3.2	DPM400-B08		
	5/32	4.0	DPM400-C08		
	3/16	4.8 - 5.0	DPM400-D08		
PS20	1/8	3.0 - 3.2	DPM400-B10	FAM400-020	DPM400-047
	5/32	4.0	DPM400-C10		
	3/16	4.8 - 5.0	DPM400-D10		
	–	6.0	DPM400-E10		
	1/4	6.4	DPM400-F10		
PS25	1/8	3.0 - 3.2	DPM400-B10	FAM400-020	DPM400-047
	5/32	4.0	DPM400-C10		
	3/16	4.8 - 5.0	DPM400-D10		
	–	6.0	DPM400-E10		
	1/4	6.4	DPM400-F10		
PS40	1/8	3.0 - 3.2	DPM400-B10	FAM400-020	DPM400-047
	5/32	4.0	DPM400-C10		
	3/16	4.8 - 5.0	DPM400-D10		
	–	6.0	DPM400-E10		
	1/4	6.4	DPM400-F10		
PS45	1/8	3.0 - 3.2	DPM400-B10	FAM400-020	DPM400-047
	5/32	4.0	DPM400-C10		
	3/16	4.8 - 5.0	DPM400-D10		
	–	6.0	DPM400-E10		
	1/4	6.4	DPM400-F10		
PRP26A	3/32	2.4	PRP31	PRP27	PRP30
	1/8(*)	3.0 - 3.2(*)	PRP39	PRP11	
	1/8(**)	3.0 - 3.2(**)	PRP32		
	5/32	4.0	PRP33A	PRP12A	

Note: Tool furnished with PRP32 and PRP11 and PRP30 parts only.

(*) Closed end

(**) Open end

Power Tools Nosepieces & Jaws

POP® Power Tools are designed to be easily maintained. The full range of spare parts is available - see the tool manuals for details. To order replacement nosepieces, jaws and jaw pushers, select from the list below.

Items supplied with the tool
Tool not specified for this rivet size
Rivet not available

ProSet® 1600 Series

Rivet Diameter

in	(mm)
	2.0
3/32	2.4
1/8	2.8 - 3.2
5/32	4.0

Nosepieces - Rivet Types					Jaws	Jaw Pusher
Open End	Closed End		HR Rivets			
	Steel Mandrel	Aluminum Mandrel	Steel Body			
Part No	Part No	Part No	Part No		Part No	Part No
PRN214					PRG402-02	FAN239-176
PRN314					PRG402-8A	FAN239-176
PRN414	PRN424	PRN434	PRN4HR		PRG402-8A	DPN239-144
PRN514	PRN524	PRN534			PRG402-8A	DPN239-144

ProSet® 2500 Series

Rivet Diameter

in	(mm)
	2.0*
*3/32	2.4
1/8	2.8 - 3.2
5/32	4.0
3/16	4.8

Nosepieces - Rivet Types					Jaws	Jaw Pusher
Open End	Closed End		HR Rivets			
	Steel Mandrel	Aluminum Mandrel	Steel Body			
Part No	Part No	Part No	Part No		Part No	Part No
PRN214					PRG402-02	FAN239-172(†)
PRN314					PRG402-8A(†)	FAN239-172(†)
PRN414	PRN424	PRN434	PRN4HR		13300	FAN275-028
PRN514	PRN524	PRN534	PRN5HR(**)		13300	FAN275-028
PRN614	PRN624	PRN634	PRN6HR		13300	DPN275-027

(*) Order PROSET 2501 or PROSET 2501MCS to set (2.0mm) and 3/32" (2.4mm) rivets.

(**) Use DPN275-027 Jaw pusher

(†) Supplied with PROSET2501 or PROSET2501MCS

ProSet® 3400 Series

Rivet Diameter

in	(mm)
1/8	2.8 - 3.2
5/32	4.0
3/16	4.8
1/4	6.4

Nosepieces - Rivet Types					Jaws	Jaw Pusher
Open End	Closed End		HR Rivets			
	Steel Mandrel	Aluminum Mandrel	Steel Body			
Part No	Part No	Part No	Part No		Part No	Part No
PRN414	PRN424	PRN434	PRN4HR		PRG540-46	FAN276-064
PRN514	PRN524	PRN534	PRN5HR		PRG540-46	FAN276-064
PRN614	PRN624	PRN534	PRN6HR		PRG540-46	DPN276-006
PRN811	PRN822				PRG540-44	DPN276-006

510A Series

Rivet Diameter

in	(mm)
	2.0
3/32	2.4
1/8	2.8 - 3.2
5/32	4.0
3/16	4.8

Nosepieces - Rivet Types					Jaws	Jaw Pusher
Open End	Closed End		HR Rivets			
	Steel Mandrel	Aluminum Mandrel	Steel Body			
Part No	Part No	Part No	Part No		Part No	Part No
PRN214					PRG402-02	
PRN314						
PRN414	PRN424	PRN434	PRN4HR		PRG402-8A	PRG520-33
PRN514(†)	PRN524	PRN534	PRN5HR			
PRN614(*)	PRN624					

(†) Except stainless steel rivets (*) Except steel and stainless steel rivets and all MultiGrip rivets materials.

Power Tools Nosepieces & Jaws

Items supplied with the tool
Tool not specified for this rivet size
Rivet not available

540 Series

Rivet Diameter in (mm)		Nosepieces - Rivet Types				Jaws	Jaw Pusher
		Open End	Closed End		HR Rivets	Part No	Part No
			Steel Mandrel	Aluminum Mandrel	Steel Body		
1/8	2.8- 3.2	PRN414	PRN424	PRN434	PRN4HR	PRG540-46	PRG14
5/32	4.0	PRN514	PRN524	PRN534	PRN5HR		
3/16	4.8	PRN614	PRN624	PRN634	PRN6HR(*)	PRG540-44	PRG740-7A
1/4	6.4	PRN811	PRN822				

(*) Use PRG540-44 Jaws and PRG740-7A Jaw Pusher

5250A Series

Rivet Diameter in (mm)		Nosepieces - Rivet Types				Jaws	Jaw Pusher
		Open End	Closed End		HR Rivets	Part No	Part No
			Steel Mandrel	Aluminum Mandrel	Steel Body		
1/8	2.8- 3.2	PRN414	PRN424	PRN434	PRN4HR	PRG540-46	PRG520-33
5/32	4.0	PRN514	PRN524	PRN534	PRN5HR		
3/16	4.8	PRN614	PRN624	PRN634			

5400 Series**

Rivet Diameter in (mm)		Nosepieces - Rivet Types				Jaws	Jaw Pusher
		Open End	Closed End		HR Rivets	Part No	Part No
			Steel Mandrel	Aluminum Mandrel	Steel Body		
1/8	2.8- 3.2	PRN414	PRN424	PRN434	PRN4HR	PRG540-46	PRT5500-6
5/32	4.0	PRN514	PRN524	PRN534	PRN5HR		
3/16	4.8	PRN614	PRN624	PRN634	PRN6HR(†)	PRG540-44	PRT5500-8
1/4	6.4	PRN811	PRN822		PRN8HR(*)		

(†) Use PRG540-44 Jaws and PRG5500-8 Jaw Pusher (*) Use PRG540-44 Jaws and DP249-008 Jaw Pusher

(**) 5400 Series has been replaced by 3400 Series

5800L Series

Rivet Diameter in (mm)		Nosepieces - Rivet Types				Jaws	Jaw Pusher
		Open End	Closed End		HR Rivets	Part No	Part No
			Steel Mandrel	Aluminum Mandrel	Steel Body		
3/32	2.4	MCS5800-14				MCS5800-11	MCS5800-15
1/8	2.8- 3.2	MCS5800-15	MCS5800-14	MCS5800-15			
5/32	4.0	MCS5800-17	MCS5800-16	MCS5800-17			
3/16	4.8	MCS5800-18	MCS5800-17	MCS5800-18			

Riveting Systems

Rivet Presenter



Rotary bowl rivet feeding system

Used in conjunction with a POP® rivet tool the Rivet Presenter System offers single-handed, high-speed rivet feeding and setting. Automatic mandrel collection of up to 8500 mandrels can be achieved by adding the MCS5000 remote mandrel collector.

Each time the front of the rivet tool is inserted into the receptacle at the front of the Rivet Presenter, a rivet is automatically and instantaneously loaded into the front of the tool. Rivets are stored in a rotary feeder bowl and continuously fed down a track into the receptacle ready for the next cycle.

Features & Benefits:

- Feeder bowl capacity up to 1000 rivets
- Feeder bowl refilled in a few seconds
- Significant reductions in riveting cycle times possible
- Manual rivet feeding is eliminated enabling a white glove environment
- Single-handed operation leaves one hand free for other operations
- Enclosed feeder bowl and mandrel collection help keep working environment free from spilled rivets and mandrels
- For use with 1/8"-3/16" (3.2mm-4.8mm) rivets

In addition to the RP unit you must order a receptacle specific to each POP® tool. eg; to set a 1/8" rivet with PROSET1600MCS order RP4-486 receptacle.

Specifications

Model Number	For Rivet Diameter	Rivet Capacity
RP4	1/8" (3.2mm)	1000 Rivets
RP5	5/32" (4.0mm)	600 Rivets
RP6	3/16" (4.8mm)	400 Rivets

Height	13.25" (337 mm)
Length	21.75" (553 mm)
Width	8.75" (223 mm)
Weight	23 lb (10.5 kg)

Air pressure: 70-90psi (4.8-6.1 bar), dry filtered

Power supply: 110 VAC, 50-60 Hz (0.5 Amp) standard flange

Receptacle

Tool Series	Rivet Diameter [in/(mm)]		
	1/8 (3.2)	5/32 (4.0)	3/16 (4.8)
ProSet 1600MCS & MCS510A	RP4-486		RP6-486
ProSet 2500MCS	RP4-350		RP6-350
ProSet 3400MCS & MCS540	RP4-501		RP6-501
ProSet 2100MCS & MCS5400*	RP4-290		RP6-110

*PROSET2100MCS & MCS5400 were replaced by PROSET2500MCS and PROSET3400MCS

Riveting Systems SmartSet®



Process monitoring for rivets

SmartSet® gives manufacturers an off-the-shelf and affordable system for monitoring the resulting joint or fastening integrity when setting POP brand blind rivets.

A Micro Strain Sensor connected to the rivet tool takes readings during the rivet setting cycle and sends them to a Control Unit. In RUN mode, the system will monitor each sequential setting and compare this with the sample settings to determine a GO or NO GO result. Outputs from the Control Unit can be connected to an audible or visual alarm to alert the user to NO GO results.

Application Capability:

- Riveting failures: Head Ejection, Pull Thru's and Remote Mandrel Breakage
- Rivet set in air detection
- Use of incorrect rivet type

System Capability:

- Rivet accountability
- Sequencing
- Program Multiple Grips within the Application - PLC selectable
- Input/Output communication available (PLC compatible)
- User defined GO and NO GO signal output

Specifications:

Control Unit	
Electrical Power	Adapter Input: 110-230VAC 50/60 Hz. 0.5Amp Adapter Output: 24VDC 0.62Amp. 15W I/O 6 Inputs, 4 Outputs
Dimensions	7.5" (L) x 4.25" (W) x 3" (H) 195mm (L) x 144 mm (W) x 77 mm (H)
Weight	1.98 lb (0.9 kg)
Custom Cable Length	Application Specific

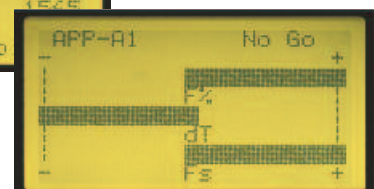

Note: SmartSet® is customized for your specific application.
Contact your representative for assistance.

Riveting Systems

Point&Set®



Automatic riveting system

Point&Set® is the ultimate in portable auto-feed POP® riveting. High speed and operator controlled, the Point&Set® system is the best solution for high volume POP® riveting where freedom of movement is required.

The Point&Set® can be integrated into a fully automated robotic rivet setting cell. Emhart engineers can assist in the provision and integration of the PLC program. The riveting tool assembly is available with an in-line tool, pistol tool or a 4-point mounting plate for straightforward mounting on a robotic or pantograph arm.

Features & Benefits:

- External feed mechanism gives reliable and jam-free loading
- Modular construction enables easy service and maintenance
- Operator Interface module for programming and self diagnostics
- Uses all standard POP® rivet ranges
- For use with rivet diameters 1/8" to 3/16" (3.2mm - 4.8mm)
- Sets up to 35 rivets per minute
- Collects spent mandrels for easy recycling

Specifications:

- **Console Dimensions:** 30" x 17" x 28" (762mm x 432mm x 711mm)
- **Tool Dimensions:** 8" x 2.25" x 13" (203mm x 57mm x 330mm)
 - Pistol Tool:** 8" x 2.25" x 13" (203mm x 57mm x 330mm)
 - In-Line Tool:** 6" x 2.25" x 13" (152mm x 57mm x 330mm)
- **Console Weight:** 185lb (84Kg)
- **Tool Weight:** 5lb 4oz (2.3Kg)
- **Feeder Capacity:** Up to 2500 rivets
- **Mandrel Capacity:** Up to 8000 mandrels
- **Electrical:** 120 VAC 60Hz
- **Air Pressure:** 90 psi (6.2 bar) @ 12 scfm (340 liter/min) dry filtered



In-line tool



Pistol tool

Creating the Future...Worldwide

**Creating the Future is about growth, it's about change,
and it's about taking risks.**

At Emhart we believe in seeking ways to serve our customers better. We create the future by anticipating our customers needs. Through diversifying our product lines, creating unique assembly technologies and offering a breadth of service to the demands of industry worldwide, Emhart provides technological solutions to over 100 different industries.

Emhart product lines include:

POP® Riveting Systems

Heli-Coil® Insert Systems

Dodge® Threaded Inserts

Gripco® Nut Assemblies



AMERICAS

USA - Connecticut

Emhart Teknologies
4 Shelter Rock Lane
Danbury, CT 06810 USA
Tel. 877-EMHART1
Tel. 877-364-2781
Fax 800-225-5614
emhart.cs@sbdinc.com

Canada

Emhart Teknologies
9870 Boulevard du Golf
Anjou, Quebec
Canada H1J 2Y7
Tel: +1 514 351 0330
Fax: +1 514 351 0458

Mexico

Emhart Teknologies
Av. Antonio Dovalí Jaime No 70
Torre B Piso 9
La Fe, Santa Fe
Mexico, D.F. 01210
Tel. +52-55-5326-7100
Fax +52-55-5326-7141

Brazil

Emhart Teknologies
Emhart Refal
Rua Ricardo Cavatton, 226
CEP: 05038-110 São Paulo
Brazil
Tel: +52 55 11 3871 6460
Fax: +52 55 11 3611 3505

EUROPE

United Kingdom

Emhart Teknologies
Tucker Fasteners
177 Walsall Road
Birmingham, B42 1BP
United Kingdom
Tel: +44 121 356 4811
Fax: +44 121 356 1598
csduk@bdk.com

The Netherlands

Emhart Teknologies
P.O. Box 514
6190 BA Beek
Europalaan 12
6199 AB Maastricht-Airport
The Netherlands
Tel: +31 43 750 2020
Fax: +31 43 750 2030

Spain

Emhart Teknologies
Sistemas de Fijacion Tucker
Carretera M-300
KM. 29,700
28802 Alcalá de Henares
Madrid, Spain
Tel: +34 91 887 1470
Fax: +34 91 882 3602
sft.pedidos@bdk.com

France

Emhart Teknologies
Emhart SNC
Zone Immoparc
Route de Chartres, Bât Loire 4
78190 TRAPPES
France
Tel: +33 1 30 50 91 00
Fax: +33 1 30 51 07 08
csdfr@bdk.com

Germany

Emhart Teknologies
Tucker Fasteners GmbH
Max-Eyth-Strasse 1
D-35394 Giessen
Germany
Tel: +49 641 405 0
Fax: +49 641 405 366
pop.de@bdk.com

Norway

Emhart Teknologies
Emhart Sjong
PO Box 203
Skjutbanevägen 6
S-701 44 Örebro
Sweden
Tel: +47 22 90 99 90
Fax: +46 19 26 00 38
info@emhart-teknik.se

Denmark

Emhart Teknologies
Emhart Harttung A/S
Farverland 1B
DK-2600 Glostrup
Denmark
Tel: +45 44 84 11 00
Fax: +45 44 84 62 12
salg.danmark@bdk.com

Sweden

Emhart Teknologies
Emhart Teknik AB
PO Box 203
Skjutbanevägen 6
S-701 44 Örebro
Sweden
Tel: +46 19 20 58 00
Fax: +46 19 26 00 38
info@emhart-teknik.se

Finland

Emhart Teknologies
Emhart Finland
Hyttimestarinkuja 4 PL 25
FI-02781, Espoo
Finland
Tel: +358 9 819 0060
Fax: +358 9 812 428
myynti.emhart@bdk.com

Czech Republic

Emhart Teknologies
Tucker s.r.o.
Tel: +420 725 800 454
Fax: +420 493 546 567

Poland

Emhart Teknologies
ul. Daleka 16
60-124 Poznan, Poland
Tel: +48 61 86 66 297
Fax: +48 61 86 65 733

ASIA

China

Emhart Teknologies
Shanghai Emhart Fastening
Systems
488 Jialou Road
Jaiding District
Shanghai 201807, China
Tel: +86 21 5954 8626
Fax: +86 21 5954 8775

Japan

Emhart Teknologies
Shuwa Kioicho Park Building 302
3-6 Kioicho, Chiyoa-Ku
Tokyo, 1020094, Japan
Tel: +81 3 3265 7291
Fax: +81 3 3265 7298

Korea

Emhart Teknologies
Seorin Building
45-15 Yeoido-Dong
Yeongdeungpo-Ku
Seoul, 150-891, R.O. Korea
Tel: +82 2 783 9226
Fax: +82 2 783 9228

India

Emhart Teknologies
APEX Towers, 5th Floor
No 54, 2nd Main Road
R.A. Puram, Chennai- 600028
India
Tel: +91 44 4306 0639
Fax: +91 44 4306 0768

© 2012 Emhart Teknologies

The latest version of this catalogue is available to view and download at emhart.com

Quality systems approvals from the world's household names in manufacturing serve to reinforce accreditation to ISO14001 / ISO9001 / TS16949.

As a result of our continuous design improvement, Emhart products are subject to modification. The latest technical data and drawings are available for any specific products on request.