

Operating the Capacitor Discharge NCD+ 3200 Stud Welding Unit



Operations Manual (729-110-037)

For Software Version 1.06 and later



These instructions are for experienced operators. If you are not fully familiar with the principles of operation and safe practices for arc welding equipment, we urge you to read AWS SP - "Safe Practices" available from the American Welding Society. **Do not permit untrained persons to install, operate or maintain this equipment. Do not attempt to install or operate this equipment until you have read and fully understand these instructions.** If you do not fully understand these instructions, contact your supplier for further information. Be sure to read the Safety section before utilizing this equipment. .

NCD+ 3200 Limited Warranty

NELSON'S only warranty is that goods being sold will be free from defects in workmanship and material. This warranty is expressly in lieu of other warranties, expressed or implied and whether statutory or otherwise, including any implied warranty of merchantability or fitness for a particular purpose.

NELSON'S liability for breach of warranty shall arise only upon return of the defective goods at Buyer's expense after notice to NELSON of the claimed breach, and shall be limited to furnishing a like quantity of such goods free from such defects or, at NELSON'S option, to refunding the purchase price (less reasonable depreciation based on actual use); provided, however, that NELSON will not accept receipt of equipment returned unless buyer has previously afforded NELSON'S personnel a reasonable opportunity to inspect and repair said equipment at buyer's facility or such other location as is mutually agreeable. Notice to NELSON must be given within 30 days of such defect or failure and within one year or 500,000 welds from the date the equipment was delivered, whichever comes first. No compensation or reimbursement for transportation costs of any kind will be allowed.

Please note that this warranty does not extend beyond the original registered purchaser, and does not warrant equipment that has been modified by any party other than NELSON, or equipment that has been improperly installed, improperly operated, or misused based upon industry standards, or equipment which has not had reasonable and necessary maintenance, or equipment which has been used for operation outside of specifications for the equipment. NELSON shall never be liable for consequential damages.

NELSON reserves the right to make engineering and/or part changes, at any time without notice, as a result of our commitment to continuous improvement.

MODEL NO.	
SERIAL NO.	
SHIPPING DATE	
VOLTAGE REQUIRED	



WARNING

WARNING

The following Safety section is for your protection. It summarizes precautionary information from the references

listed in the Additional Safety Information section. Before performing any installation or operating procedures, be sure to read and follow the safety precautions listed below as well as all other manuals, material safety data sheets, labels, etc. Failure to observe these precautions can result in injury or death.

PROTECT YOURSELF AND OTHERS



Some welding, cutting, and gouging processes are noisy and require ear protection. The arc, like the sun, emits ultraviolet (UV) rays and other radiation which can harm the skin and eyes. Hot metal can cause burns. Training in the proper use of the processes and equipment is essential to prevent accidents. Therefore:

1. Always wear safety glasses with side shields in any work area, even if welding helmets, face shields and goggles are also required.
2. Use a face shield fitted with filter shade #3 per ANSI Z87.1. Cover sparks and rays of the arc when operating or observing operations. Warn bystanders not to watch the arc and not to expose themselves to the rays of the electric-arc or hot metal.
3. Wear flameproof gauntlet type gloves, heavy long-sleeve shirt, cuffless trousers, high topped shoes, and a welding helmet or cap for hair protection, to protect against arc rays and hot sparks or hot metal. A flameproof apron may also be desirable as protection against radiated heat and sparks.
4. Hot sparks or metal can lodge in rolled up sleeves, trousers cuffs or pockets. Sleeves and collars should be kept buttoned and open pockets eliminated from the front of clothing.
5. Protect other personnel from arc rays and hot sparks with suitable nonflammable partitions or curtains.
6. Use goggles over safety glasses when chipping slag or grinding. Chipped slag may be hot and can fly far. Bystanders should also wear goggles over safety glasses.



FIRES AND EXPLOSIONS

Heat from flames and arcs can start fires. Hot slag or sparks can also cause fires and explosions. Therefore:

- Remove all combustible materials well away from the work area or cover the materials with a protective nonflammable covering. Combustible materials include wood, cloth, sawdust, liquid and gas fuels, solvents, paints and coatings, paper, etc.
- Hot sparks or hot metal can fall through cracks or crevices in floors or wall openings and cause a hidden smoldering fire or fires on the floor below. Make certain that such openings are protected from hot sparks and metal.
- Do not weld, cut, or perform other hot work until the work piece has been completely cleaned so that there are no substances on the work piece which might produce flammable or toxic vapors. Do not do hot work on closed containers. They may explode.
- Have appropriate fire extinguishing equipment handy for instant use, such as a garden hose, water pail, sand bucket or portable fire extinguisher. Be sure you are trained for proper use.
- Do not use equipment beyond its ratings. For example, overloaded welding cable can overheat and create a fire hazard.
- After completing operations, inspect the work area to make certain there are no hot sparks or hot metal which could cause a later fire. Use fire watchers when necessary.
- For additional information, refer to NFPA Standard 51B, "Fire Prevention in Use of Cutting and Welding Processes," available from the National Fire Protection Association, Batterymarch Park, Quincy, MA 02269



ELECTRICAL SHOCK

Contact with live electrical parts and ground can cause severe injury or death. DO NOT use welding current in damp areas, if movement is confined, or if there is danger of falling. Faulty or improperly electrified equipment can cause injury or death. Therefore:

1. Always have qualified personnel perform the installation, troubleshooting, and maintenance work unless you are qualified to perform such work.
2. Install equipment in accordance with the U.S. National Electrical Code, all local codes and the manufacturer's recommendations.
3. Be sure the power source frame (chassis) is connected to the ground system of the input power.
4. Connect the work piece to a good electrical ground.
5. Connect the work cable to the work piece. A poor or missing connection can expose you or others to a fatal shock.
6. Use well-maintained equipment. Replace worn or damaged cables.
7. Keep everything dry, including clothing, work area, cables, torch/electrode holder and power source.
8. Make sure that all parts of your body are insulated from work and from the ground.
9. Do not stand directly on metal or the earth while working in tight quarters or a damp area; stand on dry boards or an insulating platform and wear rubber soled shoes.
10. Put on dry, hole-free gloves before turning on the power.
11. Refer to ANSI/ASC Standard Z49.1 for specific grounding recommendations. Do not mistake the work lead for a ground cable.
12. Before performing any work inside a power source, disconnect the power source from the incoming electrical power using the disconnect switch at the fuse box before working on the equipment.



ELECTRICAL AND MAGNETIC FIELDS

Electric and magnetic fields may be dangerous. Electric current flowing through any conductor causes localized Electric and Magnetic Fields (EMF). Welding and cutting current creates EMF around welding cables and welding machines. Therefore:

1. Operators having pacemakers should consult their physician before welding. EMF may interfere with some pacemakers.
2. Exposure to EMF may have other health effects which are unknown.
3. Operators should use the following procedures to minimize exposure to EMF:
4. Route the electrode and work cables together. Secure them with tape when possible.
5. Never coil the torch or work cable around your body.
6. Do not place your body between the torch and work cables. Route cables on the same side of your body.
7. Connect the work cable to the work piece as close as possible to the area being welded.
8. Keep welding power source and cables as far away from your body as possible.



MOVING PARTS CAN CAUSE INJURY

Electric fan can start at any time without warning and cause severe injury, therefore:

1. Always disconnect electrical power prior to service to prevent the fan from starting unexpectedly.
2. Keep all doors, panels, covers, and guards closed and securely in place.
3. Have only qualified people remove guards or covers for maintenance and troubleshooting as necessary.
4. Keep hands, hair, loose clothing, and tools away from moving parts.
5. Reinstall panels or guards and close doors when servicing is finished and before reenergizing welder.



FUMES AND GASES

Fumes and gases can cause discomfort or harm, particularly in confined spaces. Do not breathe fumes and gases. Shielding gases can cause asphyxiation. Therefore:

1. Always provide adequate ventilation in the work area by natural or mechanical means. Do not weld, cut, or gouge on materials such as galvanized steel, stainless steel, copper, zinc, lead, beryllium, or cadmium unless positive mechanical ventilation is provided. Do not breathe fumes from these materials.
2. Do not operate near degreasing and spraying operations. The heat or arc rays can react with chlorinated hydrocarbon vapors to form phosgene, a highly toxic gas, and other irritant gasses.
3. If you develop momentary eye, nose, or throat irritation while operating, this is an indication that ventilation is not adequate. Stop work and take necessary steps to improve ventilation in the work areas. Do not continue to operate if physical discomfort persists.
4. Refer to ANSI/ASC Standard Z49.1 (see listing on next page) for specific ventilation recommendations.



CYLINDER HANDLING

Cylinders, if mishandled, can rupture and violently release gas. Sudden rupture of cylinder, valve, or relief device can injure or kill. Therefore:

1. Use the proper gas for the process and use the proper pressure reducing regulator designed to operate from the compressed gas cylinder. Do not use adaptors. Maintain hoses and fittings in good condition.
2. Always secure cylinders in an upright position by chain or strap to suitable hand trucks, undercarriages, benches, walls, post, or racks. Never secure cylinders to work tables or fixtures where they may become part of an electrical circuit.
3. When not in use, keep cylinder valves closed. Have valve protection cap in place if regulator is not connected. Secure and move cylinders by using suitable hand trucks. Avoid rough handling of cylinders.
4. Locate cylinders away from heat, sparks, and flames. Never strike an arc on a cylinder.
5. For additional information, refer to CGA Standard P-1, "Precautions for Safe Handling of Compressed Gases in Cylinders", which is available from Compressed Gas Association, 1235 Jefferson Davis Highway, Arlington, VA 22202.



EQUIPMENT MAINTENANCE

Faulty or improperly maintained equipment can cause injury or death. Therefore:

1. Always have qualified personnel perform the installation, troubleshooting, and maintenance work. Do not perform any electrical work unless you are qualified to perform such work.
2. Before performing any maintenance work inside a power source, disconnect the power source from the incoming electrical power.
3. Maintain cables, grounding wire, connections, power cord, and power supply in safe working order. Do not operate any equipment in faulty condition.
4. Do not abuse any equipment or accessories. Keep equipment away from: heat sources such as furnaces, wet conditions such as water puddles and inclement weather oil or grease corrosive atmospheres.
5. Keep all safety devices and cabinet covers in position and in good repair.
6. Use equipment only for its intended purpose. Do not modify it in any manner.



EYE PROTECTION

Flying metal can injure eyes. Welding, chipping, wire brushing and grinding can cause sparks and flying metal. As welds cool, they can throw off slag. Therefore:

1. Wear approved safety glasses with side shields even under your welding helmet.
2. Warn others nearby about flying metal hazard.



HEARING PROTECTION

Prolonged Noise from Capacitor Discharge welding applications can damage hearing if levels exceed limits specified by OSHA. Therefore:

1. Use Approved ear plugs or ear muffs if noise level is high.
2. Warn others nearby about noise hazard.
3. For additional information, refer to OSHA Safety Standards 3074.



ADDITIONAL SAFETY INFORMATION





For more information on safe practices for electric arc welding, refer to the following publications.

1. ANSI/ASC Z49.1 Safety in Welding and Cutting
2. AWS C5.1 Recommended Practices for Plasma Arc Welding
3. AWS C5.6 Recommended Practices for Gas Metal Arc Welding
4. AWS SP Safe Practices (Reprint) Welding Handbook
5. ANSI/AWS F4.1 Recommended Safe Practices for Welding and Cutting of Containers That Have Held Hazardous Substances.

CONTENTS

1	Connection and Installation	6
1.1	Installation Precautions	6
1.2	Connection	7
1.2.1	Input Connection	8
1.2.2	Connection of Gun Welding Cable	9
1.2.3	Connection of Gun Control Cable	9
1.2.4	Dual Connection of Workpiece Ground Cable	10
1.2.5	Connection of the Workpiece	10
1.3	Specifications.....	11
1.3.1	Mechanical Drawing	12
2	Control and Display Elements	13
2.1	Front Panel Controls and Displays Weld Parameter	13
2.1.1	Voltage Display Modes.....	14
2.2	Stud Expert.....	15
2.3	Process Monitor (PM)	16
2.3.1	Teaching Welds	17
2.3.2	Setting Tolerances	18
2.3.3	Operating Process Monitor	19
3	Normal Operation	20
3.1	Powering Up	20
3.2	Welding Operations	20
3.3	Error Codes	21
3.4	Weld Quality Visual Inspection.....	22
4	Welding Parameters	23
4.1	Contact Gun.....	23
4.2	Auto-Gap Gun.....	23
4.3	Weld Setting Recommendations	24
5	NCD+ 3200 Parts List & Exploded View	25
6	Wiring Diagrams for NCD+	29
6.1	Standard System	29
6.2	Autofeed System	30
7	Nelson NCD+ Welding Modes	31
7.1	Contact Mode Capacitor Discharge Welding.....	31
7.2	Auto-Gap Mode Capacitor Discharge Welding.....	31
8	Contact Information	32

1 Connection and Installation

 <p>SAFETY SYMBOLS ATTENTION! BE ALERT!</p> <p><i>WELDING CAN BE HARMFUL TO YOURSELF AND OTHERS.</i></p>		<p>Used to call attention to immediate hazards which, if not avoided, will result in immediate, serious personal injury or loss of life.</p>
		<p>Used to call attention to potential hazards which could result in personal injury or loss of life.</p>
		<p>Used to call attention to hazards which could result in minor personal injury.</p>

1.1 Installation Precautions

Attention must be paid to the fact that the welding unit is installed on a horizontal, vibration-free and non-slip surface. The load-carrying capacity of the floor space should be at least double the weight of the unit. When working in high-lying locations, such as bridges, ladders or platforms, the NCD+ must be secured against the risk of falling.

The NCD+ must be adequately protected against the intrusion of liquids. It may not be installed on liquid-bearing pipelines.

In order to guarantee unimpeded temperature exchange with the environment, a minimum clearance of 39.4 inch (1 m) to existing heat sources must be observed.

Attention must be paid to the fact that the ventilation slits on the unit casing are kept free.



NCD+ models may exhibit permanent failure or abnormal operation when used in the vicinity of high frequency interference. TIG processes and similar high frequency processes tend to interfere with and damage NCD+ circuit boards, particularly when sharing the same work piece. For more information please consult your local Nelson service support.

1.2 Connection

With the exception of the input power cable, all of the connections are located on the front plate of the NCD+.



WARNING

Prior to any connection work, the NCD+ welding unit must be switched off. The input power switch must be in the >>0<< position.

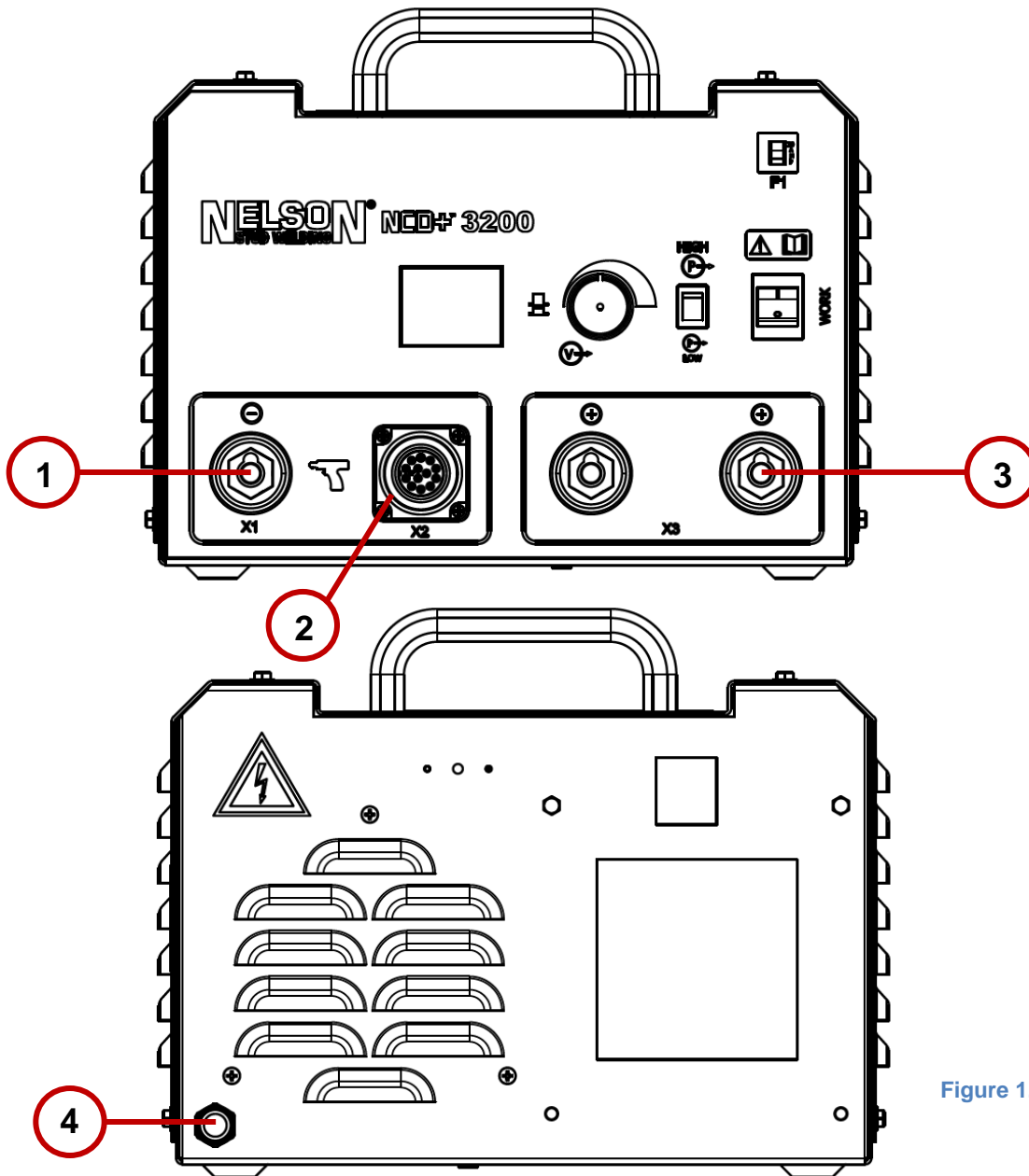

Figure 1.1 NCD+ Connection

1 Gun Welding Cable Connection (-) x1	3 Workpiece Ground Cable Dual Connection (+) x3
2 Gun Control Cable Connection x2	4 Input Power Cable Connection

1.2.1 Input Connection

The NCD+ unit can only be operated with 110-120 VAC 50/60 Hz input power (Item 4 of [Figure 1.1](#), Page 7). See the rating plate on the back panel of the unit.



The input power must be wired with the earth ground connection. It is not acceptable to use an isolation plug to isolate the earth ground connection. It could result in unsafe conditions.

Fusing with slow response characteristics.

Nelson Stud Welding, Inc 7900 West Ridge Rd, Elyria, OH 44035 USA				
Type: NCD+ 3200				
Part Nr. 750-614-620				
Serial Nr.				
$U_2 = 70 \text{ V DC} \dots 200 \text{ V DC}$				
	$U_0 < 30 \text{ V}$	I_2	10kA	28kA
		U_2	70V	200V
	$U_1 = 115 \text{ V}$	20A	$I_1 = 17 \text{ A}$	$I_1 = 17 \text{ A}$
		S_1	1955VA	1955VA
Label Part No. 724-576-017				

1.2.2 Connection of Gun Welding Cable

The Gun Welding Cable connects to the NCD+ via the Gun Welding Cable socket (Item 1 of [Figure 1.1, Page 7](#)). It must be noted that the procedural safe operation of the system can only be guaranteed when either a Nelson Contact or a Nelson Auto Lift gun is connected.

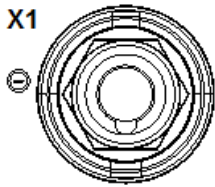

Gun Welding Cable Connection (X1)

Align the locking pin of the welding cable plug to the locking groove of the welding cable socket. Turn to the welding cable plug 1/3 of a turn to the right clockwise to secure the connection.

Figure 1.2 Gun Welding Cable Socket



Connect Gun Welding Cable to X1 for straight polarity and to X3 for reverse polarity.

1.2.3 Connection of Gun Control Cable

The Gun Control Cable socket (Item 2 of [Figure 1.1, Page 7](#)) permits the connection of the control cable to the NCD+ unit. The signals to control the gun are transmitted via the control cable.

The control cable socket of the unit has a 12-pin design.

Gun Control Cable Connection (X2)

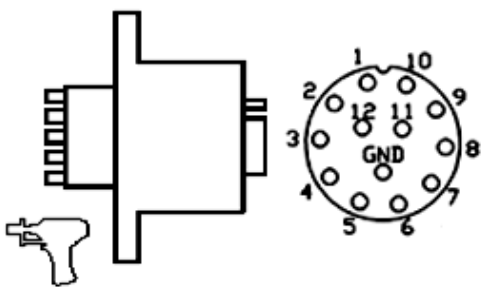

- Pin 1: LED Green
- Pin 2: LED Red
- Pin 3: Trigger
- Pin 4: Trigger
- Pin 5: Gun Coil
- Pin 6: Gun Coil
- Pin 7: Weld (+)
- Pin 8: Weld (-)
- Pin 9: Spark Shield

Figure 1.3 Gun Control Cable Socket

The connection must be secured by aligning the index of the control cable plug with the index of the control cable socket. Once the indices are aligned, turn the collar ring to the right until it's tight. Now, the connection is secure.

1.2.4 Dual Connection of Workpiece Ground Cable

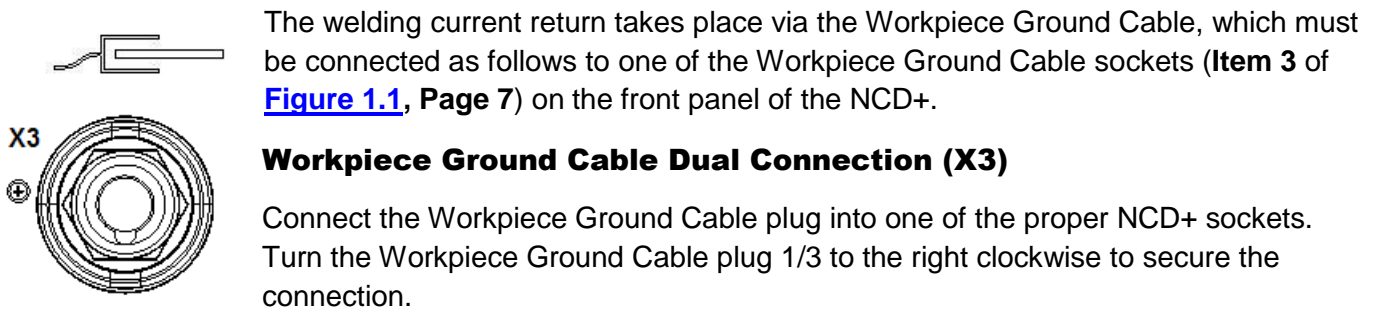

Figure 1.4 Workpiece Ground Cable



Place the 2 ground clamps on the opposite ends of the weld area to minimize arc blow.



WARNING

Prior to any connection task, the NCD+ welding unit must be switched off and the input power switch must be in the >>0<< position.

1.2.5 Connection of the Workpiece

When connecting the workpiece ground terminals, attention must be paid to the following:

The workpiece ground terminals must be connected directly to the workpiece or to the workpiece fixture (welding bench, welding grid). Steel constructions, tracks, pipelines, etc. may not be used as current conductors, unless they themselves are the workpieces to be welded. The welding current circuit may not be earth grounded. The exception is the workpiece itself or the workpiece fixture are earth grounded compulsorily (pipelines, shipbuilding, etc.). Place the workpiece ground terminals, if possible, at the same distance from the point of welding when two ground clamps are used.

1.3 Specifications

NCD+ 3200™ CD WELDING UNIT		MIN.	MAX.
Input Voltage (V) / Current (A)		120/20	
Input Line Frequency (Hz)		60	
Capacitor Voltage (VDC) (Continuously Adjustable)		70	200
Stored Energy (Ws)		3750	
Capacitance (mF) (High/Low Switchable)		81	189
Weight		64 lbs (30 kg)	
Weld Rate (studs/min)	Low Capacitance, 120V	20	
	High Capacitance, 180V	8	
Maximum Stud Thread Diameter	Steel/Stainless (TFTC/S)	3/8" Flanged	
	Aluminum (TFTA)	5/16" Flanged	
Dimensions (Length x Width x Height)		20" x 13.25" x 8.5" (508 mm x 336.5 mm x 216 mm)	
Power Cord		9 ft (2.75 m)	
Idle Power (W)		80 or less	
Operating Temperature (°C)		-20 to +40	
Storage Temperature (°C)		-40 to +60	
Gun Connector		12-Pin Binder	
Weld Connector		Dinse	
Dual Ground		Yes	
Compatible Guns		NCD+ Contact, NCD+ Auto-Gap	
Process Monitor		Yes – Optional	
Contact Safety Check		Yes	
Chuck Saver		Yes	
Stud Expert		Yes	
Display		Graphic Color Display	

1.3.1 Mechanical Drawing

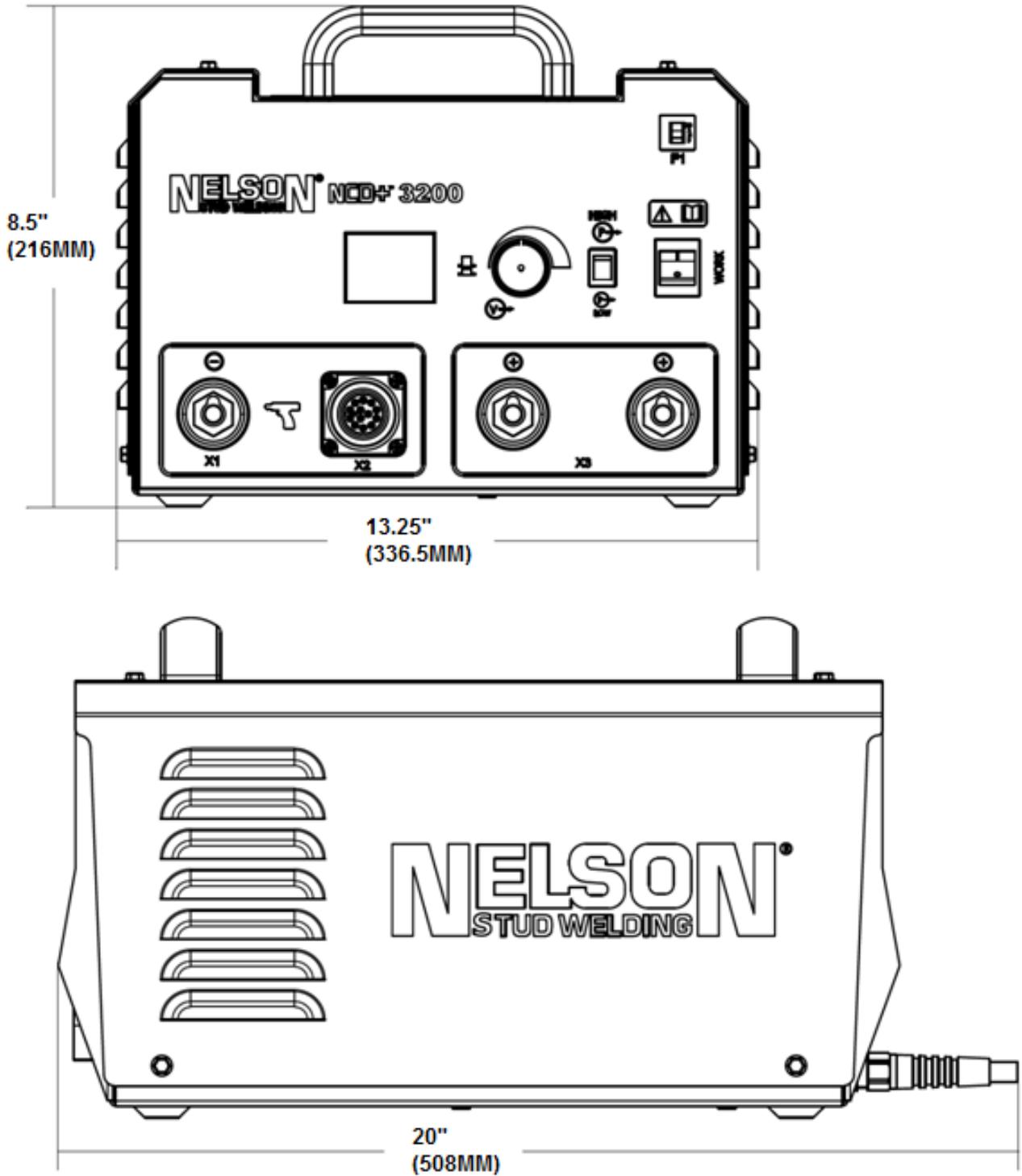

Figure 1.5 Front & Side Views of NCD+ 3200 with Dimensions

2 Control and Display Elements

2.1 Front Panel Controls and Displays Weld Parameter

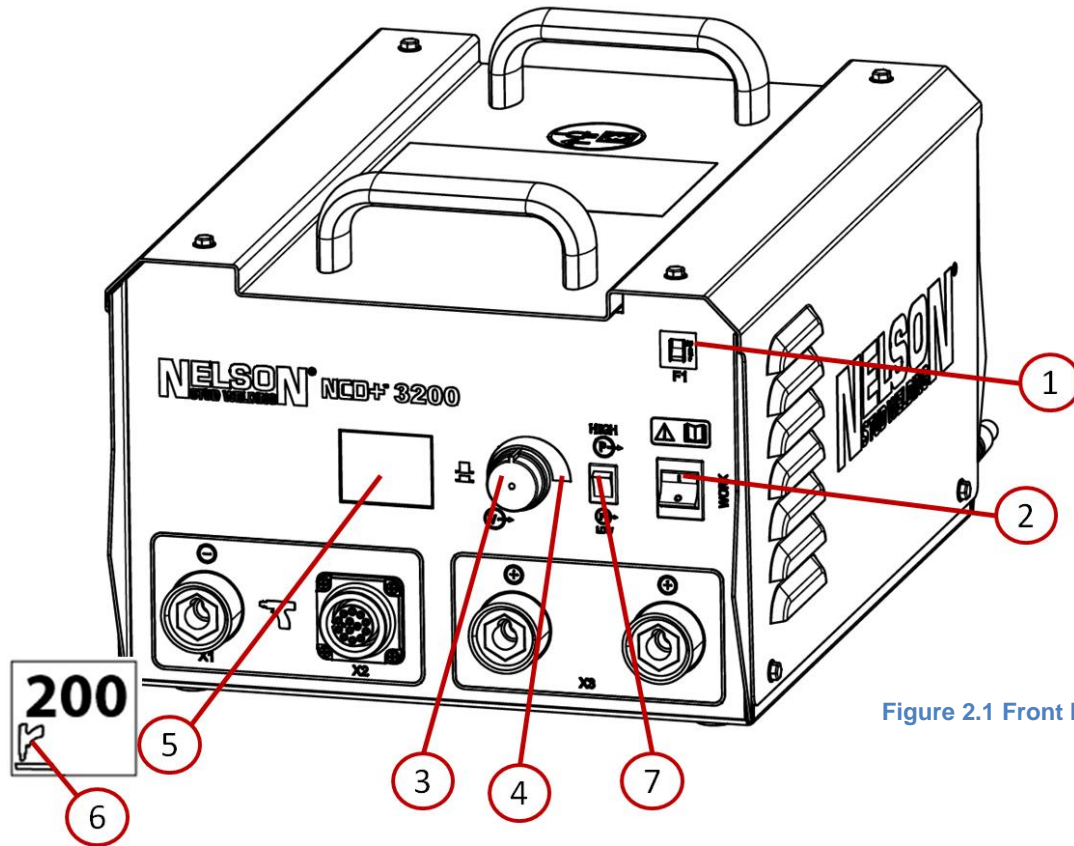

Figure 2.1 Front Panel Controls

1	Circuit Breaker	Primary circuit breaker to protect the welding transformer from overloads (resettable).
2	On/Off Power Switch	The main switch controls the input power to the machine. Upon powering up, the internal control software performs a series of diagnostic tests to ensure correct connection and safe operation of the power source.
3	Function Mode	Press the knob to alternate between modes.
4	Adjustment of Voltage and Other Parameters	Enables voltage selection. The voltage is increased turning the knob in the clockwise direction (or decreased by turning it in the counterclockwise direction). The power supply will take a moment to achieve and display the new voltage setting. Note: Small changes make it easier to reach a new voltage level.
5	Voltage Display	LCD display of voltage setting
6	Weld Tool Icon	The graphical display of gun function and welding process.
7	Capacitance Selector Switch	This switch enables toggling between high and low capacitance. When set to low capacitance, three out of seven capacitors are utilized. The low setting is typically used for studs less than 3/8" diameter. When set to high capacitance, all seven capacitors are utilized. This setting is typically used for 3/8" studs.

2.1.1 Voltage Display Modes

RED when charging is in progress. GREEN when actual voltage matches with setpoint.

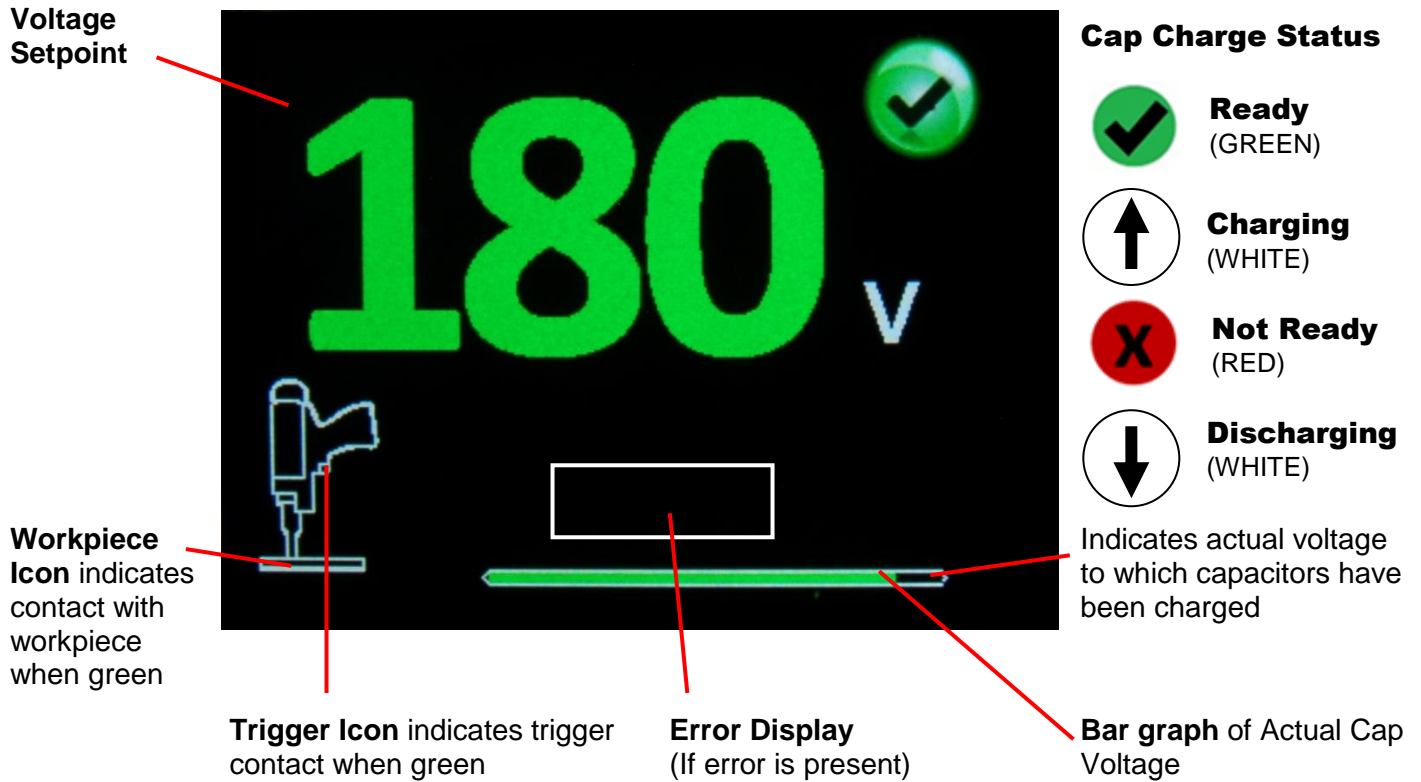

Figure 2.2 Voltage Display (Enlarged View of Items 5 & 6 of Figure 2.1)

2.2 Stud Expert

NOTE: Once the unit is powered up, press the knob once to enter the Process Monitor screen.

NOTE: To access the Setup screen, return to the Voltage Selection screen (the home screen). From the Voltage Selection screen, press and hold the knob for 5 seconds to enter the Setup screen. To exit Setup at anytime and return to the Voltage Selection screen, press and hold the knob again for 5 seconds.

The Stud Expert mode allows the user to choose welding parameters based on the desired stud size, stud material and welding process. The resulting cap voltage is set once the stud is selected.

One parameter (stud size, stud material, welding process) can be selected, or all 3, depending on what are the job requirements.

Turn the knob to scroll through the choices. Once the desired choice is highlighted, push the knob to select and confirm the choice. The

1. Select the desired stud size (**1/4in (M6)**) as shown in **Item 1** of **Figure 2.3**.

2. Choose from available studs materials, such as Carbon Steel, as seen in **Item 2**.

3. Choose your desired welding mode; view the resulting cap voltage; or exit the screen as exemplified in **Item 3**.

Resulting Cap Voltage

Exit the Screen

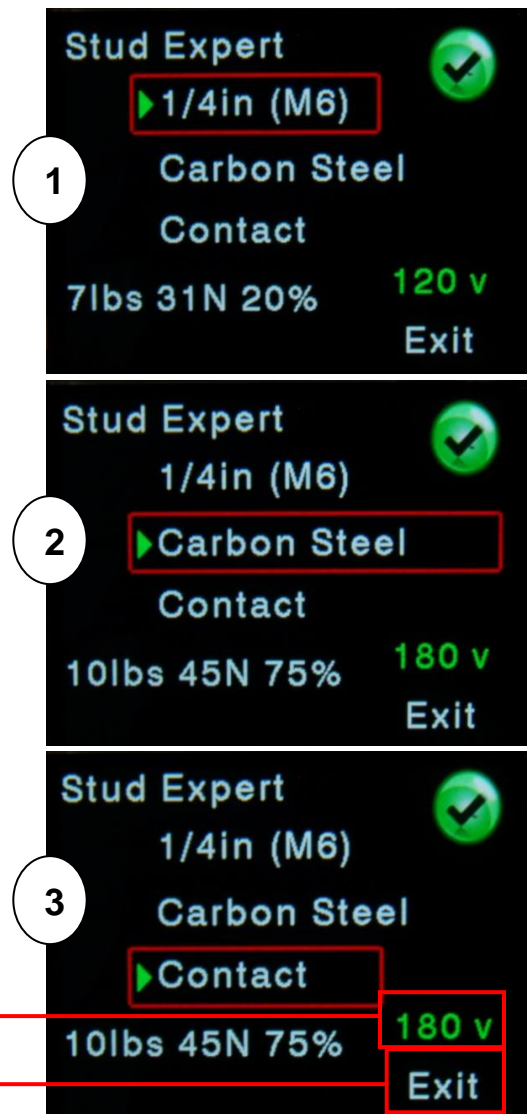

Figure 2.3 Stud Expert

2.3 Process Monitor (PM)

NOTE: Once the unit is powered up, press the knob once to enter the Process Monitor screen.

The Process Monitor uses a series of “teaching welds” as a target to check each production weld and to determine if the characteristics of a production weld fall within the natural scatter of teaching welds (“pass”).

1. Select **Teach** as shown in **Item 1** of **Figure 2.4**.

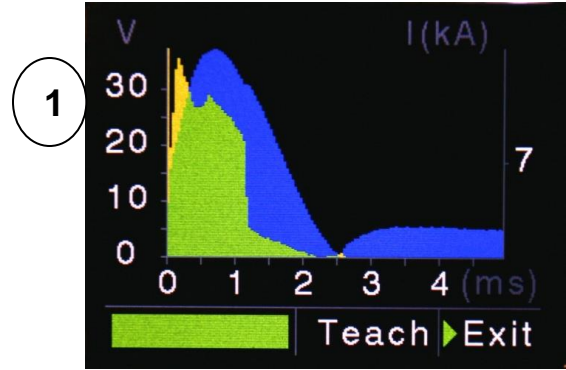

2. Before entering Teach mode, the target must be cleared. Select **Yes (Item 2)** to confirm that you want to clear any existing target before proceeding.

3. Turn the dial to desired selection and click.



4. Perform welds (ex. 8-10). *PM in progress with 5 welds recorded.*

5. Click **Done (Item 3)** once finished.

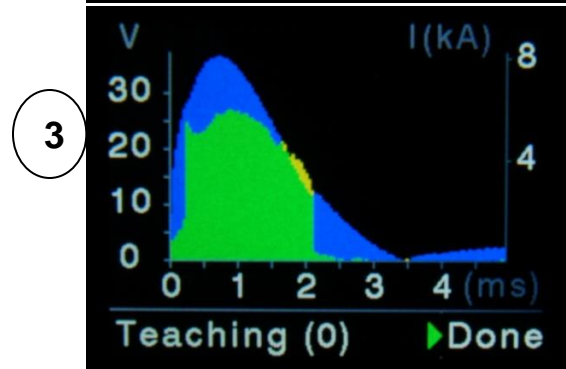

6. Verify results with **Pass/Fail Production** view (**Item 4**).

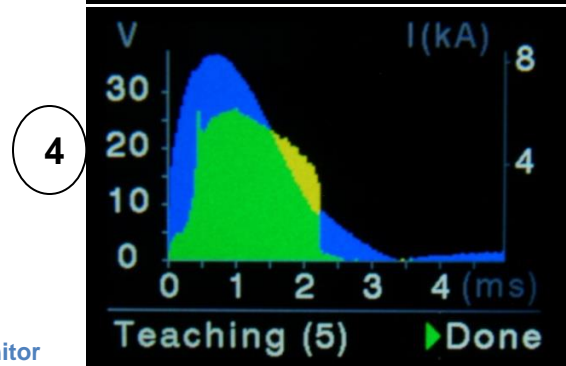

Figure 2.4 Process Monitor

2.3.1 Teaching Welds

NOTE: Once the unit is powered up, press the knob once to enter the Process Monitor screen.

NOTE: If you are unable to find the Process Monitor screen, make sure that WAVESCENBL=ON in the Setup screen. To enter the Setup screen, return to the Voltage Selection screen (the home screen) and press and hold the knob for 5 seconds. Then, follow the diagram to enter the WAVE SCN ENBL screen and to turn the mode ON.

1. To access PM Waveform view, enter Setup mode.
2. Select **WAVE SCN ENBL** (Item 1 of Figure 2.5) and select **ON** to enable (Item 2).
3. Scroll the knob until the green arrow points to **Teach**.
4. Press the knob once to reach the **Clear Target?** dialog. Scroll to select **Yes** to clear the target.
5. The **Teaching (0)** at the bottom will appear signifying that there have been no teaching welds made so far. Produce as good of a weld as you can. After welding, make sure that the scope chart updates and says **Teaching (1)**. (See diagram for the interpretation of the *PM Waveform View*).

NOTE: THE CHART LEGEND: The horizontal axis is displayed in milliseconds, the left vertical is displayed in arc voltage (volts) sensed at the gun and the right vertical is displayed in kiloamps.

6. Repeat good welds as necessary (30 welds are recommended as a minimum for teaching welds to be statistically significant).
7. Scroll the green arrow over to select **Done**.
8. Select **Exit**.

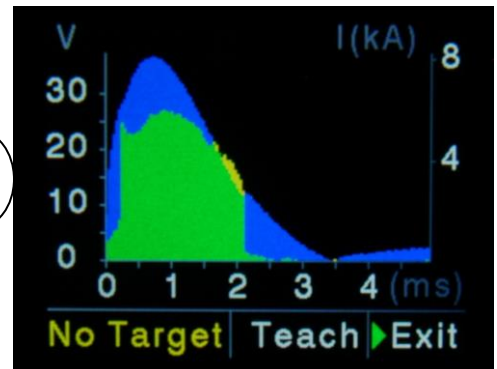
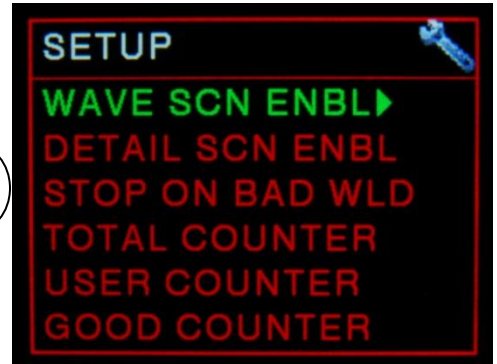

Here, no target has been taught. To enter teaching mode, turn dial to **Teach** and click. Perform welds to teach; click **Exit** to leave the Teach Mode (Item 3). This will configure a target.

PM Waveform View
Tracks Welding Data

Blue	Current
Yellow	Voltage
Green	Overlap

Figure 2.5 PM Waveform View

2.3 Teaching Welds (Cont'd)

Scroll knob to go to the Weld Results screen which should read **NO TARGET** (Item 1 of Figure 2.6) as the last weld wasn't monitored. The subsequent welds will be monitored by the new target, and the first line should indicate pass or fail (Item 2).

Scroll down for more parameters.

NOTE: There are 2 places to monitor the results for teaching: the Process Monitor screen (where the green bar = good results and the red bar = bad results) and the Weld Details screen. Each line represents a calculated parameter being monitored. The number in the square brackets indicates the deviation from the mean as a multiplier of the standard deviation. The green line means the deviation falls within the tolerance set for that parameter, and the red means it fell outside.

Represents Actual Deviation from Target

Parameter results less than Main Tolerance Mult, or **MAIN TOL MULT**, are 'good'

For example:

Main Tolerance = 3x

ArcT is less than 3 = Good

Avgl is greater than 3 = Bad

1

2

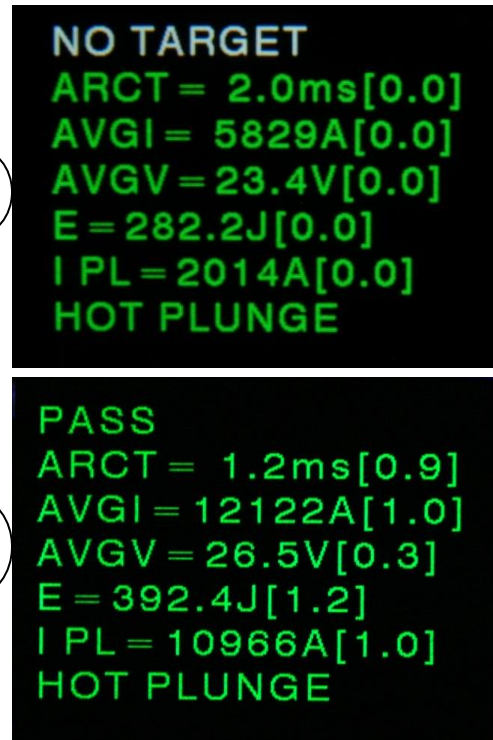

Figure 2.6 Weld Results Screen

2.3.2 Setting Tolerances

NOTE: Once the unit is powered up, press the knob once to enter the Process Monitor screen.

1. From the Voltage Selection screen, press and hold knob for 5 seconds to enter Setup screen.
2. Scroll down to highlight **MAIN TOL MULT** (Figure 2.7). Press the knob once to select the mode.

MAIN TOL MULT is the multiplier (1x, 2x, 3x...) for Teach mode which automatically selects individual tolerances.

Factory default is 3x. The tolerance of each parameter can be individually adjusted.

Higher values allow more room for leniency; whereas lower values tighten the process.

Must retrain unit after adjusting **MAIN TOL MULT**. Adjusting individual tolerances does not require retraining.



Figure 2.7 MAIN TOL MULT Screen

Adjust or disable individual parameters (ArcT, ENERGY, TIP, etc) to override tolerances automatically set by teaching and **MAIN TOL MULT** (Figure 2.8).

Scroll down through the Setup screen for more individual tolerances.



Figure 2.8 IPLUNGE TOL Screen

2.3.3 Operating Process Monitor

NOTE: Once the unit is powered up, press the knob once to enter the Process Monitor screen.

To setup the tolerances effectively, destructive testing is needed to separate the good from the bad welds.

To test the Process Monitor (PM):

First, perform several normal welds which should pass. If they fail, go to the Weld Details screen and check which parameter(s) have failed (they will appear in red) and go to the Setup screen to open up the tolerance or disable the parameter for checking. One of the conditions below should fail the PM:

1. Stud welded out of perpendicular position to the workpiece.
2. Damaged timing tip on stud.
3. Workpiece contamination.
4. Poor quality weld ground connections.

The unit can be configured to lock the user out if there is a failure. Go to Setup screen and turn on **STOP ON BAD WLD.**

After a suspect weld is detected, a popup screen will display **FAILED WELD.** Click on knob to acknowledge message before proceeding with another weld.

There is also a resettable good weld counter and a bad weld count within the Setup screen.

3 Normal Operation

NOTE: Refer to [Figure 2.1](#) (Page 13) for item references throughout the following instructions.

3.1 Powering Up

Before power up, ensure that all cables are properly connected. Press the On/Off Power switch (**Item 2**) to the right of the knob to start the unit.

Wait for a few seconds while the power supply initiates and completes both a self test and self diagnostics test (**Note: Self tests occur between every weld.**). Once the tests have completed, the power supply will charge the unit to the voltage setpoint (adjust voltage if necessary). When fully charged, the Cap Charge Status icon ([Figure 2.2](#), Page 14) will become a green checkmark to show that the unit is fully charged and ready to weld.

3.2 Welding Operations

1. Set the welding voltage. Wait until the Voltage Display screen (**Item 5**) lights up green.
2. Rotate the knob (**Item 3**) to the desired level of voltage.
3. Set the spring pressure.
4. Adjust foot/leg assembly to set the plunge.
5. Load the stud into the chuck. Press the stud against the workpiece (Ensure that the stud is perpendicular to the workpiece). The Workpiece icon will light up green.
6. Pull the trigger to weld the stud. The Trigger icon will turn green when the trigger switch is depressed ([Figure 2.2](#), Page 14).

Note: If the stud does not make contact with the workpiece, it will not weld.

7. Remove the chuck from the welded stud.
8. The unit automatically recharges - wait for the Cap Charge Status icon ([Figure 2.2](#), Page 14) to turn green again before proceeding with the next weld. The unit will not recharge even if the trigger is pulled again before the chuck is removed from the welded stud known as the **Chuck Saver™**.

3.3 Error Codes

Only qualified personnel should perform maintenance. Some functional errors are highlighted by appearance of an error code with the display EXX.

Error Number	Malfunction	Solution
E01	Abnormal presence of voltage on studs when there should be no voltage.	 <p>Stop using the Power Source until issue is resolved. Measure weld terminals voltage (VDC) to confirm.</p> <ul style="list-style-type: none"> •If ≥ 30VDC, check SCR Gate Leads and replace SCR. •If < 30VDC, replace Control board and Power board.
E02	Capacitors won't charge (after 3 seconds, capacitors still less than 20V)	Replace power board. If the problem is not solved, replace SCR. If neither resolves the issue, replace the wiring harness.
E03	Capacitors are unable to discharge – either because the SCR did not fire or because the weld circuit was broken.	<ol style="list-style-type: none"> 1. Check weld circuit continuity. 2. Check SCR. 3. Replace Control Board. 4. Replace Power Board.
TEMP X°	If Thermal Sensor trips...	
	At 45°C or higher ambient temperature	Let it cool down and reset it to 35°C.
	At 45°C or lower ambient temperature	Replace control board.
TEMP SW	Trip with thermal switch mounted on heat-sink	Let it cool down. Check for loose cable connections.

3.4 Weld Quality Visual Inspection



Issue: Too cold
Weld Flash: Not Visible
Weld: Very weak, Will break
Adjustments: Increase voltage, reduce spring pressure, or increase capacitance



Issue: Acceptable Weld
Weld Flash: Normal, No significant weld splatter
Weld: Good, strong
Adjustments: None required

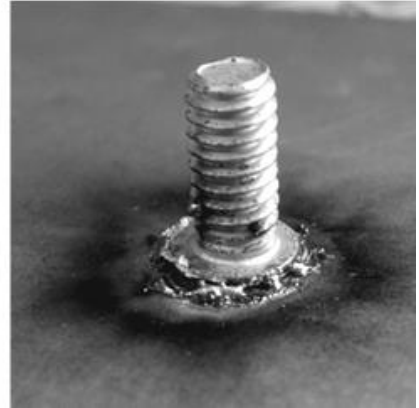

Issue: Too Hot
Weld Flash: Excessive flash and weld splatter
Weld: Weak, May break
Adjustments: Reduce voltage, increase spring pressure, or reduce capacitance

4 Welding Parameters

4.1 Contact Gun

Stud Size	Material	Plunge Depth		Pressure			Capacitance	NCD+™ 3200 Voltage
		in	mm	lbs	N	%		
#6 (M3)	Carbon Steel	0.12	3	12	53	100	Low	80
	Stainless Steel	0.12	3	12	53	100	Low	70
#8 (M4)	Carbon Steel	0.12	3	6	27	0	Low	80
	Stainless Steel	0.12	3	11	49	100	Low	80
#10 (M5)	Carbon Steel	0.12	3	9	40	50	Low	90
	Stainless Steel	0.12	3	7	31	25	Low	80
1/4" (M6) [6.4 mm]	Carbon Steel	0.12	3	10	45	75	Low	120
	Stainless Steel	0.12	3	7	31	25	Low	115
5/16" (M8) [7.9 mm]	Carbon Steel	0.12	3	9	40	50	Low	180
	Stainless Steel	0.12	3	10	45	75	Low	180
3/8" [9.5 mm]	Carbon Steel	0.12	3	10	45	25	High	180
	Stainless Steel	0.12	3	10	45	25	High	180

4.2 Auto-Gap Gun

NOTE: Set plunge (or stick out) to 2 mm. The Pressure is best measured by pressing the spark shield squarely against a scale when the timing tip of the stud is flush with the end the spark shield in the welding position.

Stud Size	Material	Plunge Depth		Pressure			Capacitance	NCD+™ 3200 Voltage
		in	Mm	lbs	N	%		
#6 (M3)	Carbon Steel	0.12	3	7	31	20	Low	80
	Stainless Steel	0.12	3	9	40	50	Low	80
	Aluminum	0.14	3.5	6	27	0	Low	-
#8 (M4)	Carbon Steel	0.12	3	6	27	0	Low	90
	Stainless Steel	0.12	3	9	40	50	Low	90
	Aluminum	0.14	3.5	9	40	50	Low	95
#10 (M5)	Carbon Steel	0.12	3	6	27	0	Low	95
	Stainless Steel	0.12	3	6	27	0	Low	90
	Aluminum	0.14	3.5	9	40	50	Low	110
1/4" (M6) [6.4 mm]	Carbon Steel	0.12	3	6	27	0	Low	155
	Stainless Steel	0.12	3	6	27	0	Low	145
	Aluminum	0.12	3	7	31	20	Low	130
5/16" (M8) [7.9 mm]	Carbon Steel	0.08	2	6	27	0	Low	200
	Stainless Steel	0.08	2	9	40	50	Low	200

4.3 Weld Setting Recommendations

Weld Setting Change	Effect on Welds
Capacitance Increase	Hotter
Voltage Increase	Hotter
Spring Pressure Increase	Colder
Contact Mode-Plunge Increase	Colder
Gap Mode-Gap Increase	Colder
Stud Tip Length Increase	Hotter

5 NCD+ 3200 Parts List & Exploded View

*SPARE PARTS ARE INDICATED BY QUANTITIES IN SPARE COLUMN IN TABLE

#	QTY	PART NO.	DESCRIPTION	TORQUE	*SPARE
1	1	750-614-220	Chassis, NCD+ 3200		
2	2	729-114-102	Pull Handle		
3	3	85-10-02	Power Connector, Dinse	50 in/lbs	
4	1	723-247-111	Gun Connector, Process Monitor with EMI/Ferrite, Harness		1
5	1	709-274-010	Input Switch		
6	1	701-182-001	Bridge		1
7	1	723-247-103	AC Power Cord Assembly		1
8	1	717-999-020	Adjustment Knob		
9	1	701-183-000	Main SCR	30 ft/lbs	1
10	1	701-184-000	Diode	30 ft/lbs	1
11	1	709-276-001	20A Breaker		
12	1	709-276-000	High/Low Decal		
13	1	724-576-003	NCD+ 3200 Front Decal		
14	1	750-614-022	Control CPU PCB		1
15	4	524-005-325	Screw, M4 x 8, SHCS, SS	10 in/lbs	
16	5	524-005-303	Lockwasher, M4, SS		
17	3	524-005-153	Nut, Nylok, M4	10 in/lbs	
18	5	524-005-120	Washer, Flat, M4, SS		
19	8	524-005-315	Screw, Flg, M5 x 10, HHCS, Blk. Phos.	30 in/lbs	
20	1	750-614-227	NCD+ 3200 Neg. D Busbar		1
21	1	750-614-230	NCD+ 3200 Capacitor Insulator		
22	1	750-614-223	NCD+ 3200 Pos. B Busbar		1
23	1	750-614-224	NCD+ 3200 Pos. A Busbar		1
24	1	750-614-228	NCD+ 3200 Dinse Link Bar		
25	1	750-614-222	NCD+ 3200 Neg. B Busbar		1
26	1	750-614-225	NCD+ 3200 Neg. A Busbar		1
27	3	750-614-231	NCD+ 3200 Capacitor Clamp Bushing		
28	3	750-614-232	NCD+ 3200 Capacitor Clamp Spacer		
29	1	750-614-226	NCD+ 3200 Neg. C Busbar		
30	2	705-610-002	Shunt		
31	1	750-614-221	NCD+ 3200 Cover		

NCD+ 3200 Manual | NCD+ 3200 Parts List & Exploded View

32	5	524-005-339	Nut, Hex, M6, SS	20 in/lbs	
33	10	524-005-273	Nut, KEPS, M6, SS	20 in/lbs	
34	1	524-005-279	Screw, M4 x 16, PHMS, SS	10 in/lbs	
35	1	750-614-229	NCD+ 3200 Shunt Connector		
36	16	524-005-311	Washer, Belleville, M6, SS		14
37	33	524-001-309	Washer, Flat, 1/4", SS		14
38	1	717-999-013	Fan		
39	1	714-033-000	Grommet		
40	3	524-005-270	Screw, M4 x 60 PHMS, SS	20 in/lbs	
41	4	524-005-272	Nut, KEPS, M3, SS	10 in/lbs	
42	1	723-247-108	Transformer Assembly		
43	2	724-462-010	Nelson Logo Decal		
44	3	524-005-337	All Thread, M6 x 160		
45	2	524-005-293	Screw, M6 x 30, HHCS, SS	80 in/lbs	
46	0.4"	103-479-000	Thermal Tape		
47	1	750-614-060	NCD+ Power Board Assembly		1
48	17	524-005-326	Screw, M6 x 14, HHCS, SS	40 in/lbs	14
49	1	724-576-017	NCD+ 3200 Rating Decal		
50	1	724-485-010	Electrical Ground Label		
51	1	524-005-289	Nut, M8 SS		
52	1	87-05-19	Unplug Before Service Label		
53	1	724-569-000	Warning Label		
54	1	724-576-015	Made In USA Label		
55	4	524-005-329	Screw, M8 x 12 PHMS, SS	40 in/lbs	
56	5	524-005-288	Lock Washer, M8, SS		
57	7	702-119-000	Capacitor, 27mf		2
58	5	524-005-287	Washer, M8 Flat, SS	60 in/lbs	
59	4	524-005-271	Screw, M3 x 12 PHMS, SS	10 in/lbs	
60	1	87-09-35	Cardiac Pacemaker Label		
61	6	724-485-015	Small High Voltage Label		
62	2	524-005-302	Washer, M3 Flat, SS		
63	1	524-005-354	Screw, M8 X 16 HHCS, SS		
NS	1	723-247-101	Power Board to Control Board Harness		
NS	1	723-247-102	Power Board to Shunt, XFMR, Discharge Resistor & Cap Switch Harness		

NCD+ 3200 Manual | NCD+ 3200 Parts List & Exploded View

NS	1	723-247-104	Power Board to Caps, Fan & Bridge Harness		
NS	1	723-247-105	(-) DC Bridge to (-) Cap Buss Harness		
NS	1	723-247-107	Voltage Sense Resistor Harness		
NS	1	723-247-012	Power Switch to Circuit Breaker Wire		
NS	1	723-247-206	Voltage Selection Jumper Plug		
NS	1	560-300-015	NCD+ 3200 Inner Carton		
NS	1	750-614-249	NCD+ 3200 Harness Kit		
NS	1	750-614-248	NCD+ 3200 Sheetmetal Kit		
NS	1	750-614-247	NCD+ 3200 Assembly Kit		
NS	1	560-200-005	NCD+ 3200 Foam Inserts		
NS	1	560-300-014	NCD+ 3200 Shipping Carton		

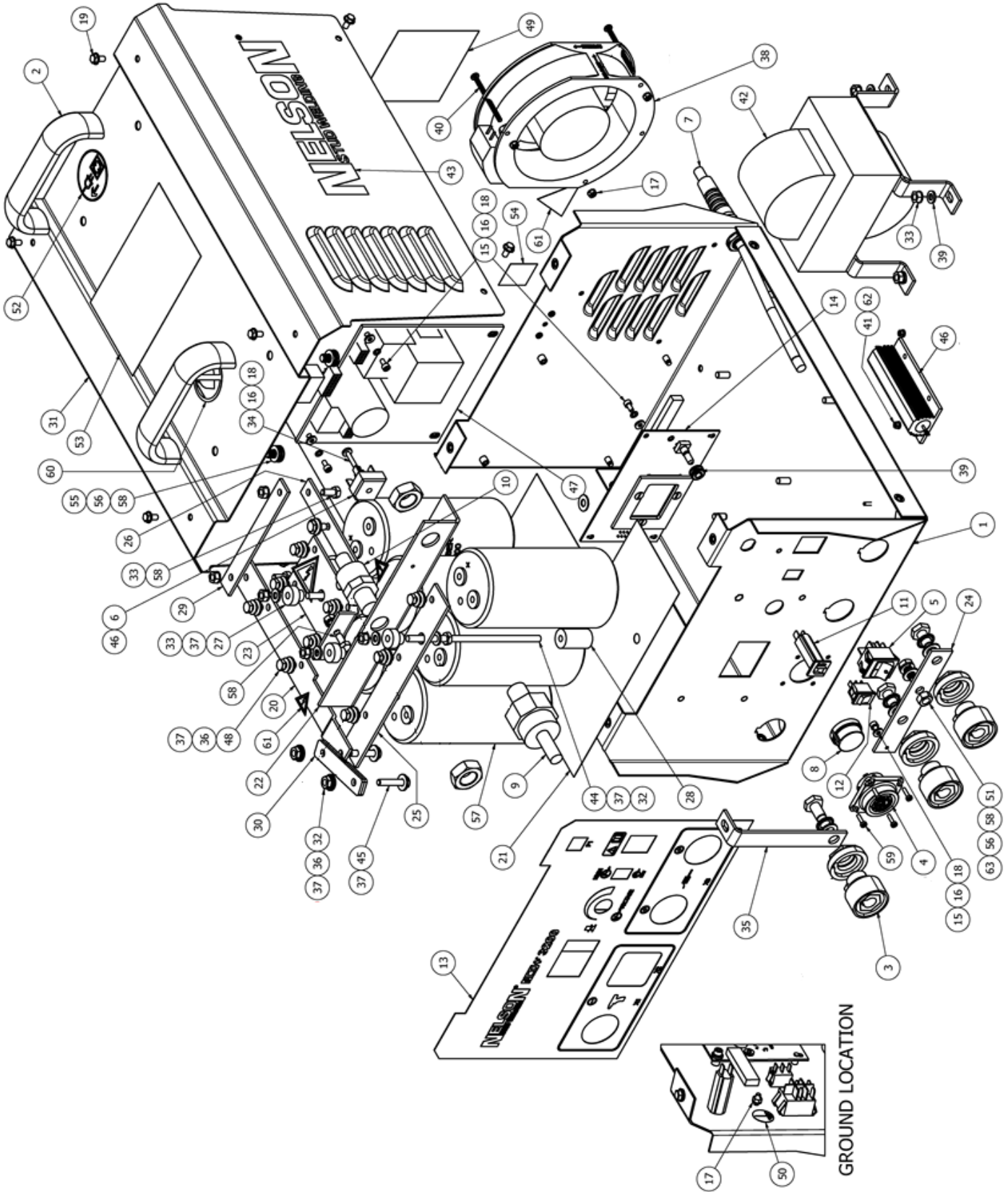

6 Wiring Diagrams for NCD+

6.1 Standard System

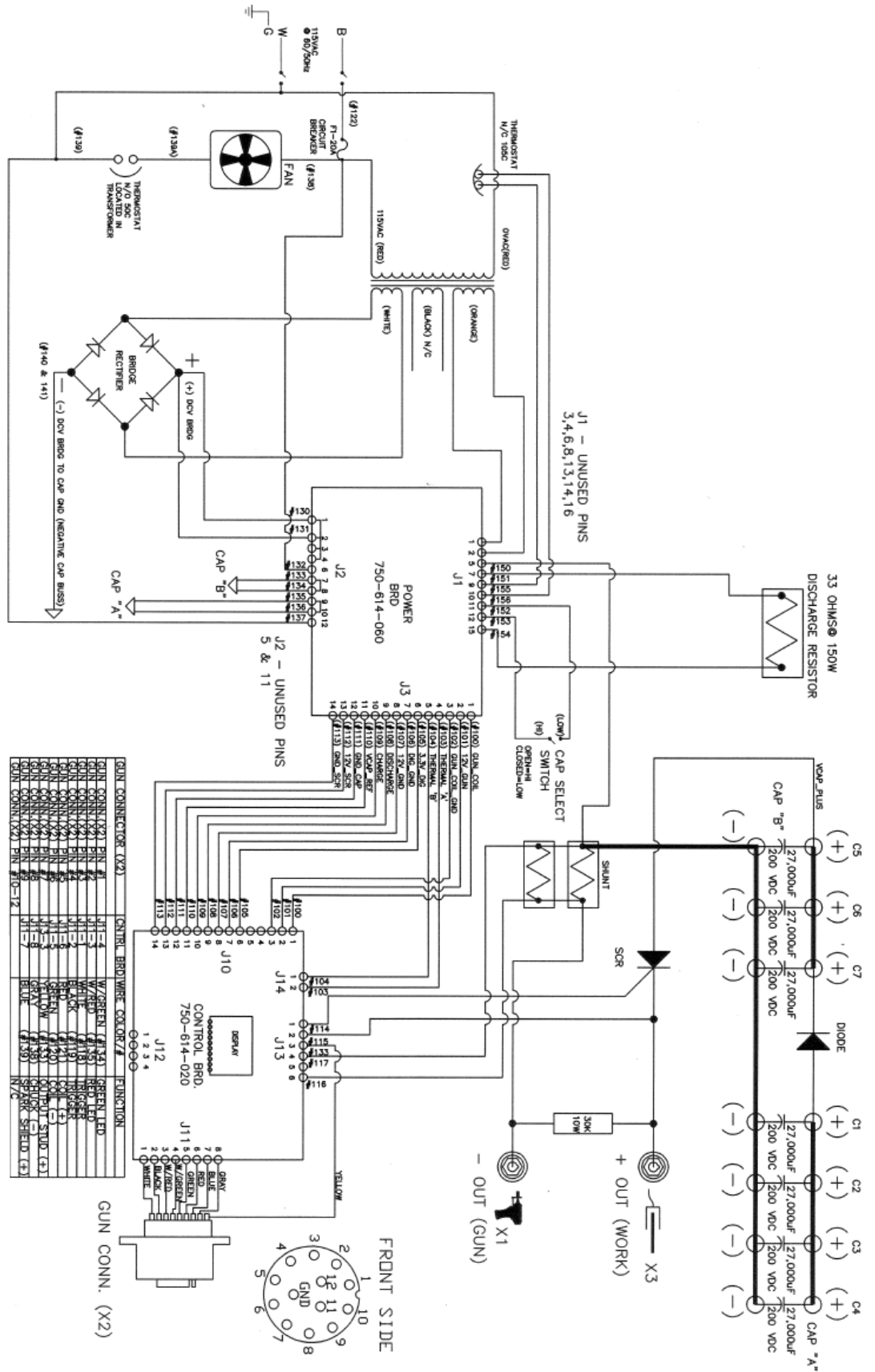

6.2 Autofeed System

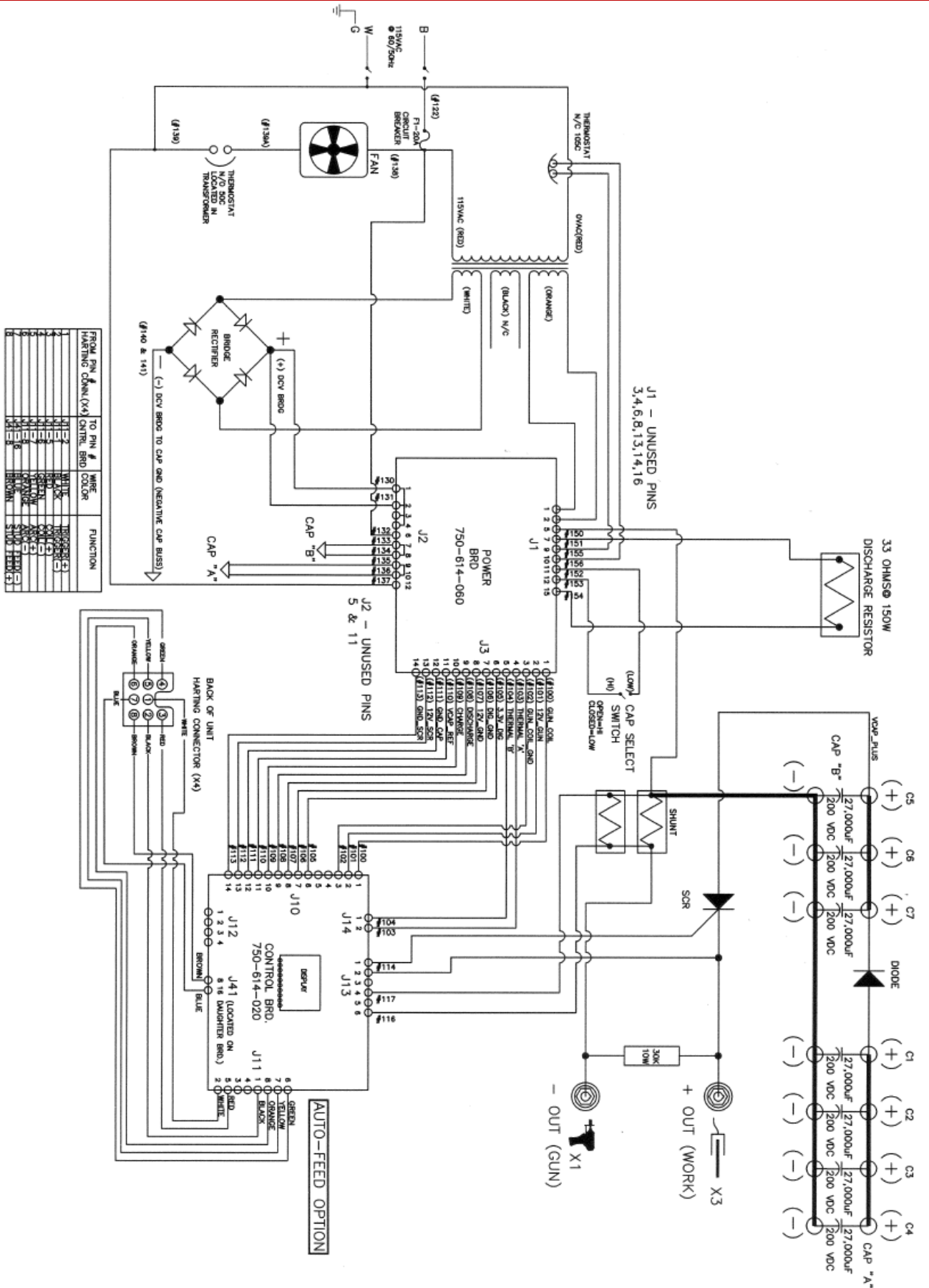

7 Nelson NCD+ Welding Modes

There are 2 modes of the CD welding process offered with the NCD+ line of equipment: Contact and Auto-Gap. Each method has its own uses and set-up requirements. The method you select will be determined by the metals to be joined, the esthetics strength and fixturing. Nelson Stud Welding will assist you in determining which method best suits your needs.

7.1 Contact Mode Capacitor Discharge Welding

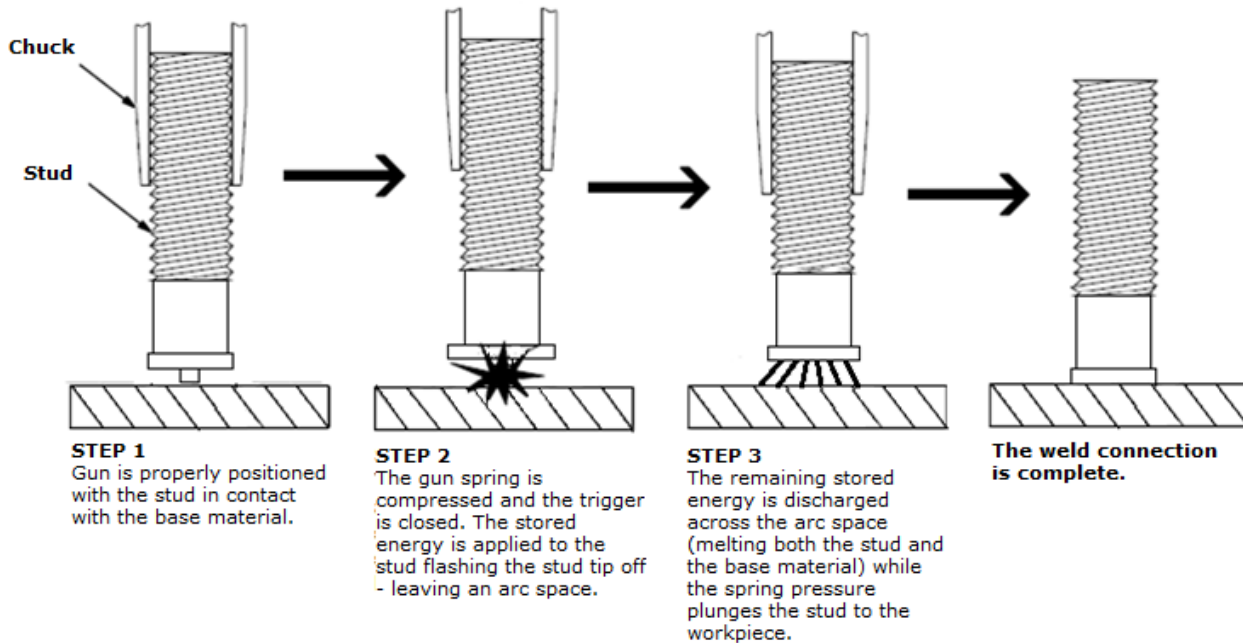

7.2 Auto-Gap Mode Capacitor Discharge Welding

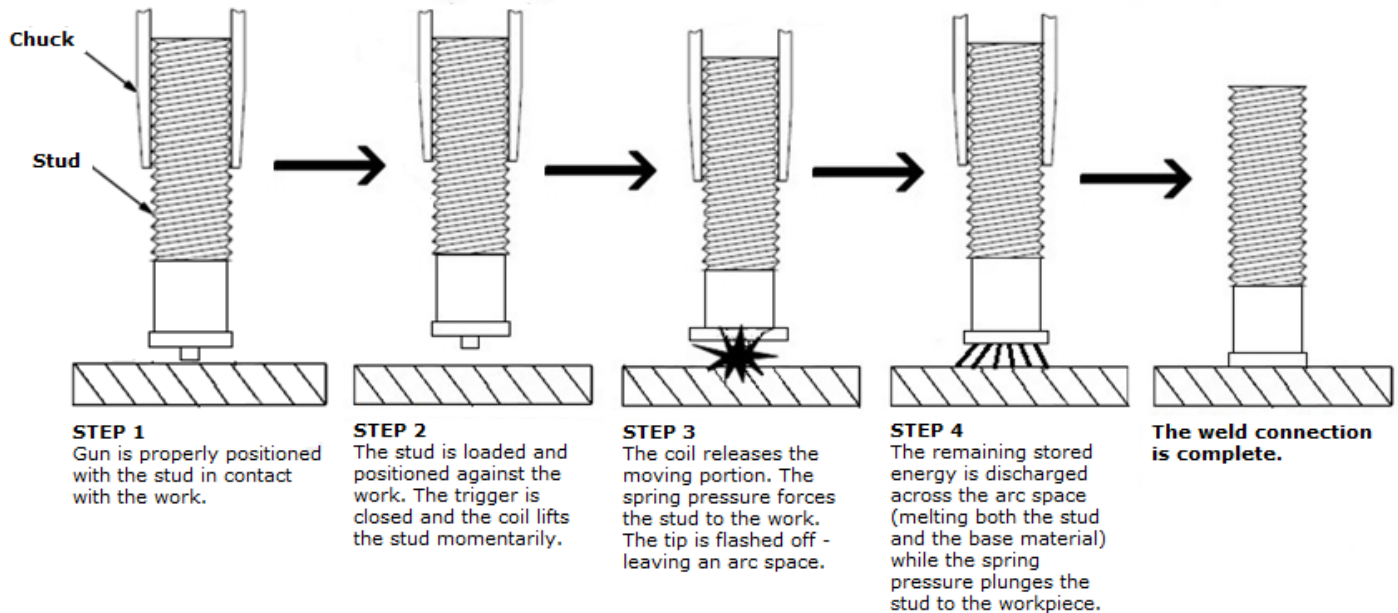

8 Contact Information

North America Sales Offices and Warehouses			
<p>*Chicago 18601 Graphic Court Tinley Park, IL 60477 708.430.3770 Phone: 800.635.9353 Fax: 708.430.3975</p>	<p>*Philadelphia 260 Boot Road Downingtown, PA 19335 Phone: 610.873.0012 800.635.9353 Fax: 610.873.2550</p>	<p>**Elyria 7900 West Ridge Road P.O. Box 4019 Elyria, OH 44036-2019 Phone: 440.329.0400 Fax: 440.329.0521</p>	<p>*Westlake 835 Sharon Drive Westlake, OH 44145 Phone: 440.250.9242</p>
<p>*Dallas 2211 Century Center Blvd. Suite 105 Irving, TX 75062 Phone: 972.721.9055 800.635.9353 Fax: 972.438.7883</p>	<p>*San Francisco 23765 Foley Street Hayward, CA 94545 510.293.0660 Phone: 800.635.9353 Fax: 510.293.0677</p>	<p>*Toronto 6199A Danville Rd. Mississauga, Ontario Canada L5T 2H7 Phone: 905.795.8277 800.635.9353 905.795.8275</p>	<p>*Los Angeles 20621B East Valley Blvd. Walnut, CA 91789-2731 Phone: 909.468.2105 800.635.9353 Fax: 909.468.2112</p>
Subsidiaries		International	
<p>England <i>Nelson U.K. Ltd.</i> 47-49 Edison Rd. Rabans Lane Ind'l Estate Aylesbury HP19 8TE, UK Phone: 44.1296.433500 Fax: 44.1296.487930</p>		<p>Middle East & Asia/Pacific 7900 West Ridge Rd. P.O. Box 4019 Elyria, OH 44036-2019 USA Phone: 440.329.0400 Fax: 440.329.0597 World Wide Web: NelsonStudWelding.com E-mail: Nelson.Sales@NelsonStud.com</p>	
<p>France <i>Nelson Frances S.A.S.</i> Z. 1 du Chemin Vert 8 rue de l'Angoumois F-95100 Argenteuil, France Phone: 33.1.3411.9400 Fax: 33.1.3411.2033</p>		<p>Central & South America P.O. Box 3990 Seminole, FL 33775 USA Phone: 727.596.9600 Fax: 727.593.3494</p>	
<p>Germany <i>Nelson Germany</i> Mailing Address Postfach 40-20 58272 Gevelsberg Germany Shipping Address Flurstrasse 7-19 58285 Gevelsberg Germany Phone: 49.2332.661.0 Fax: 49.2332.661.165</p>		<p>For Distributors in specific areas call: 440.329.0400</p> <p>General Offices 7900 West Ridge Rd. P.O. Box 4019 Elyria, OH 44036-2019 USA Phone: 440.329.0400 Fax: 440.329.0597 World Wide Web: NelsonStudWelding.com E-mail: Nelson.Sales@NelsonStud.com</p>	
<p>Italy <i>Nelson Italy</i> Via Miraflores, 20 Nichelino, (TO) I-10042 Italy Phone: 39.011.6059238 Fax: 39.011.6059230</p>			